

pH- and Redox-Converter UNICON[®]-pH

pH- and ORP measurement with standard electrodes

Features

- Measuring range programmable
pH value pH-1.00 ... +15.00, ORP -1500 ... +1500mV,
temperature compensated,
- Monitoring of impedance,
glass- and reference electrode
and calibration cycle as well
- Measuring range for pH/ORP
switchable by external signal
- Temperature measurement programmable
for Pt100 or Pt1000 sensor
- Output 4 ... 20mA, 2-wire loop powered
for temperature measurement
- 2 alarm outputs, voltage free
- Isolation between output/
range-switch input/electrode
- Simulation mode (manual operation)
for pH, ORP and temperature



Headmounting



Fieldmounting

Note:
Electrodes and fittings must be ordered separately

General information

The Converter UNICON-pH is used among other things in the food technology, in chemistry, in pharmaceutical industry and in the sewage technology. Depending upon structural conditions can be selected between field mounting (electrode and converter are mounted separately) and head mounting (electrode and converter form one unit). The UNICON-pH operates with all common pH- and ORP-electrodes.

Short information

Programming	Parameters are programmed via front side membrane keypad.
Alarm output	Switching performance is programmable as minimum or maximum function. The state of the alarm outputs is shown in the LCD-display.
Electrode monitoring	One alarm output is selectable for impedance protection of the glass-and reference electrode against broken glass and break of wire.
Measuring range/ measuring pH/ORP switching	A second measuring range for pH or ORP can be selected by switching by an external control signal. It is also possible to change from pH to ORP measurement and reverse.

Content

Page

Technical data	2-3
Dimensions.....	3
Connection diagrams/terminals.....	4-6
Legend (cover plate)	6
Controls- and display.....	7
Installation	7
Notes about calibration.....	8, 22
Calibration modes of the UNICON-pH	9
Programming.....	10
Calibration/configure	10
Automatic calibration	11-12
Manual calibration	13-15
Data calibration	16
ORP calibration	16
Configuration.....	17-20
Error codes.....	21
Mounting notes.....	21
Replacement of electrodes at in-line fittings for head mounting.....	22
Operation notes for pH / ORP electrodes	22-23
Ordering code.....	24

Technical data

Power supply

Supply voltage	: 14 ... 30 V DC, 2-wire, loop powered
Operating temperature	: 0 ... 50 °C (32 ... 122 °F)
Isolation	: pH - and ORP output/temperature output/alarm output 1/ alarm output 2/range switch input
Test voltage	: 500 V DC
CE - conformity	: acc. to EN50022, IEC61000-4-3/4/5

pH / ORP

Output signal	: 4 ... 20 mA
Burden	: RA [Ω] ≤ $\frac{\text{Supply voltage} - 14 \text{ V}}{0.02 \text{ A}}$
Measuring range	: programmable in range pH-1.00 ... +15.00 or -1500 ... +1500 mV
Input resistance	: > 10 ¹² Ω
Input current	: < 10 ⁻¹² A
Electrode zero point	: pH = 7.00 (ΔpH = ± 2.0)
Slope	: 30 ... 80 mV / pH
Offset ORP	: ± 200 mV
Error	: ± 0.2 % of the range or ± 2Digit
Temperature coefficient	: <100 ppm/°C
Measuring derate	: approx. 2/sec.
Type of calibration	: - manual input of buffer value, 1- or 2-point calibration - automatic buffer identification of the buffer solution: -WTW; technical buffer with the nominal values 4.01/7.00 in range 0 ... 95 °C/10.00 in range 0 ... 50 °C -Schott; technical buffer with the nominal values 4.00/7.00/10.00 in range 0 ... 40 °C -Ingold; (Mettler Toledo) technical buffer with nominal values 4.01/7.00/9.21 in range 0 ... 95 °C -buffer acc. to DIN 19266 with nominal values 4.01/6.87/9.18 in range 0 ... 95 °C - data entering of the value for zero point and slope - ORP offset

Temperature

Output signal	: 4 ... 20 mA
Burden	: RA [Ω] ≤ $\frac{\text{Supply voltage} - 14 \text{ V}}{0.02 \text{ A}}$

Temperature sensor RTD : Pt100 or Pt1000
 Unit : programmable °C; °F
 Measuring range : programmable -40.0 ... +160.0 °C (-40.0 ... +320.0 °F)
 Min./max. span : 25.0 °C (45.0 °F)/200 °C (360.0 °F)
 Accuracy : ± 0.1% ± 1 Digit
 Temperature coefficient : < 50 ppm/°C
 Linearization error : ± 0.1 %
 Glass impedance : 0 ... 1 GΩ (temperature compensated)
 - Measuring range : 0,001 ... 2 GΩ (not compensated)
 - Accuracy : ±20 %
 Reference impedance : 0 ... 100 kΩ (not compensated)
 - Accuracy : ±20 %
 Monitoring of the calibration interval : 1 ... 1000 days

Alarm output

Transistor output : 14 ... 30 V DC, max. 60 mA, short circuit protection
 Voltage drop : < 2 V

Range switch

Input resistance : >10 KΩ
 Range 1 active : U = 0 ... 3 V DC
 Range 2 active : U = 12 ... 30 V DC

Display

: LCD-dot matrix, character height 3.8 mm
 2 lines, 16 characters each

Case

Model : head mounting/field mounting, protection IP65
 Material : Polyamide with fibreglass PA6-GF 15/15
 Weight : 0.36 kg
 Connection : Screw terminal with pressure plate, 2.5 mm² fine wire, 4 mm² single wire
 Front keypad : Polyester

Dimensions

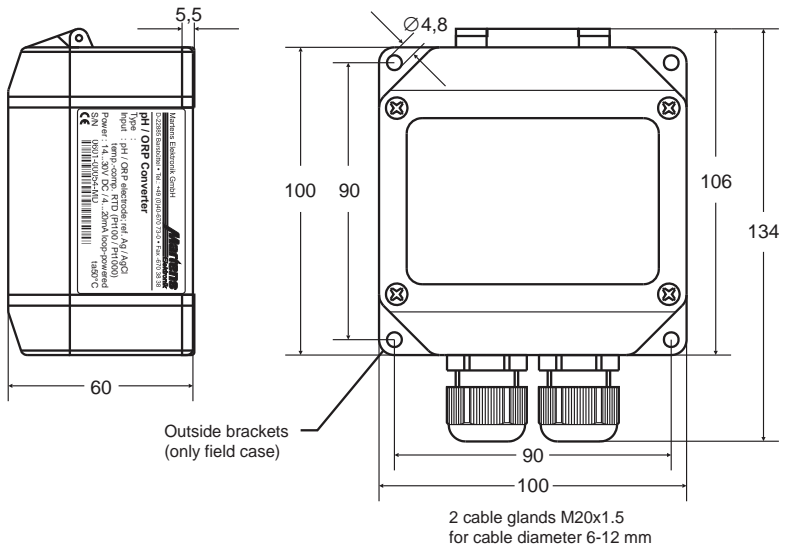

Connection diagrams/terminals

1. pH-combination electrode with integr. temperature sensor

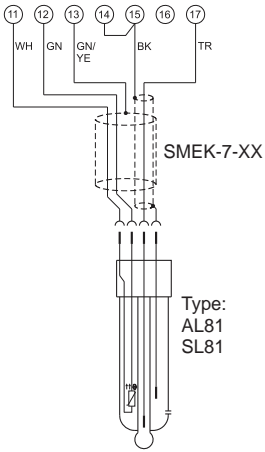

2. pH-combination electrode with ext. temperature sensor

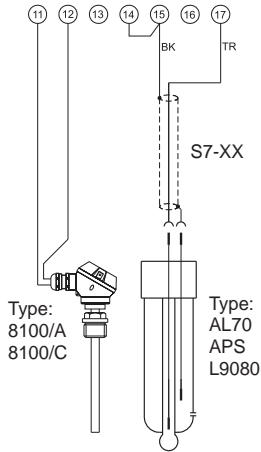

3. pH-combination electrode with ORP-electrode

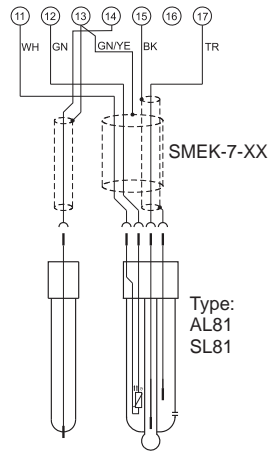

4. pH-combination electrode with integr. temperature sensor and ext. liquid ground

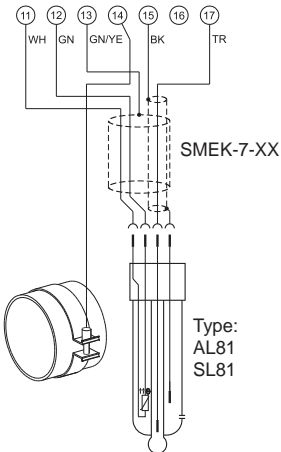

5. ORP-combination electrode with ext. temperature sensor

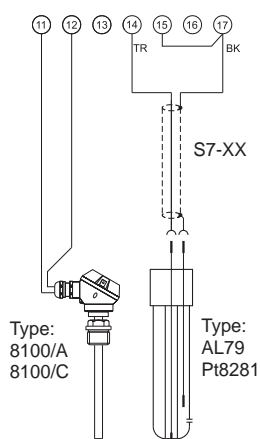

Terminal description see next page

Picture 1 and 2

Terminal	Measuring input	SMEK-7-XX*	S7-XX*
11	Temperature sensor Pt100/Pt1000	white (WH)	
12	Temperature sensor Pt100/Pt1000	green (GN)	
13	Shield	green/yellow (GN/YE)	
14	ORP-electrode/ liquid ground	link to terminal 15	
15	Reference electrode	black (BK)	black (BK)
16	not used		
17	Glass electrode	transparent (TR)	transparent (TR)

Picture 3 and 4

Terminal	Measuring input	SMEK-7-XX*
11	Temperature sensor Pt100/Pt1000	white (WH)
12	Temperature sensor Pt100/Pt1000	green (GN)
13	Shield	green/yellow (GN/YE)
14	ORP-electrode/ liquid ground	
15	Reference electrode	black (BK)
16	not used	
17	Glass electrode	transparent (TR)

Picture 5

Terminal	Measuring input	S7-XX*
11	Temperature sensor Pt100/Pt1000	
12	Temperature sensor Pt100/Pt1000	
13	Shield	
14	ORP-electrode/ liquid ground	transparent (TR)
15	Reference electrode	link to terminal 17
16	not used	
17	Glass electrode	black (BK)

* -XX = cable length [m]

Connection diagram / terminals

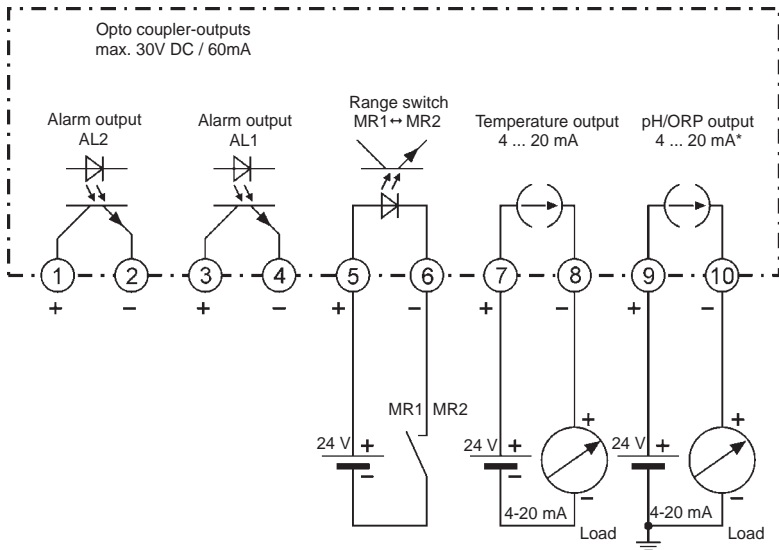

* For supplying the converter use terminals (9) and (10) as shown. If the converter is used for monitoring only, terminals (9) and (10) must be connected directly to supply voltage.

Legend (cover plate)

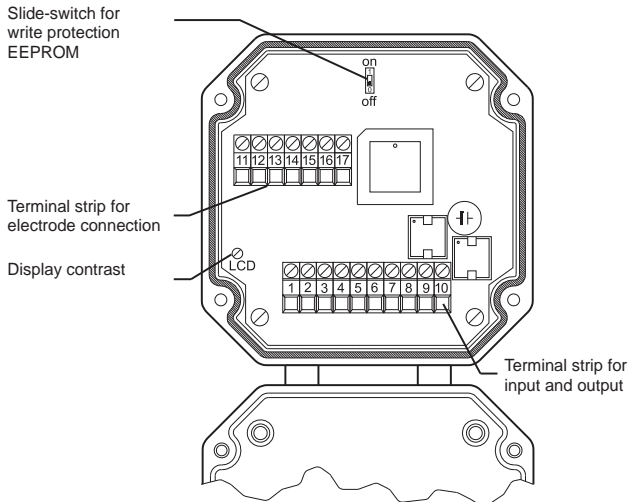

Controls and display

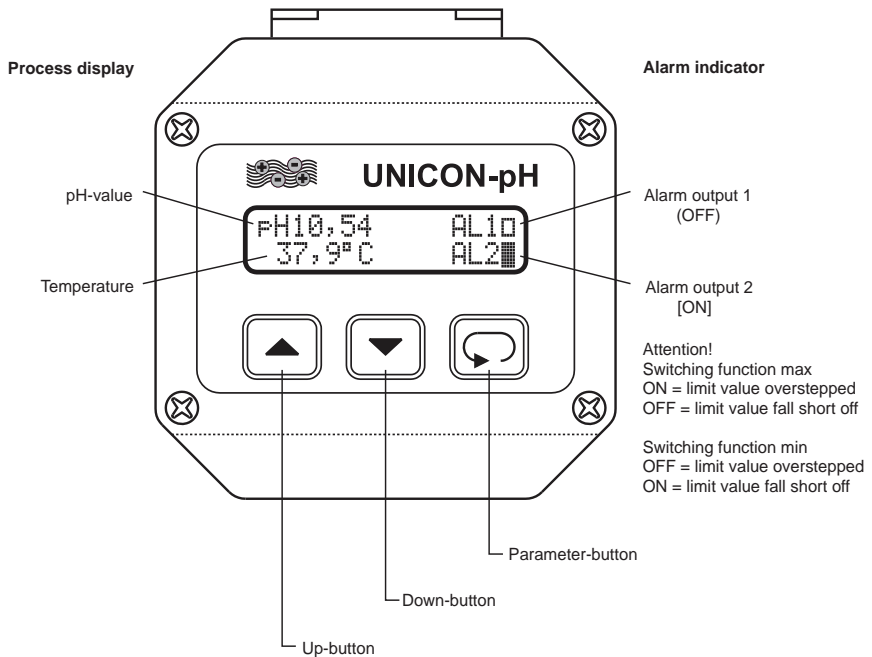

Description

After switching on the supply voltage, the converter initializes itself. The display shows messages about the device type and software version. After the initializing procedure the converter displays the process values in the working level.

Operating of the device is arranged in 2 levels. The requested parameter can be called by the button . Selection within a parameters or entering data, use buttons and . Parameters are stored zero voltage safe in the EEPROM.

The configuration level is called up by pressing the button . Now all parameters defining the function of the converter can be programmed.

After finishing the configuration or if longer than 120 seconds no button was pushed, the program returns to the working level. Leaving the configuration level is possible at any time by pushing the button for 2 seconds.

Installation note!

Before the device can be used, it must be configured for the intended use.

Notes about calibration.

In practice the characteristic curves of pH electrodes deviate from the ideal line. For precise measurement it is necessary to calibrate the UNICON-pH on the used pH-electrode when setting in operation and afterwards in regular time intervals. Standardised pH buffer solutions can be used to check measuring points of the connected pH-electrode.

Maximum operating values for correct measurement: Zeropoint 6.0 ... 8.0 pH; slope 53.0 ... 59.2 mV/pH.

Single point calibration:

The pH-electrode is calibrated with one pH buffer solution only. The program moves the characteristic curve parallel through the calibration point (see diagram A).

- practicable if the pH value of the process solution is close to the pH value of the buffer solution, no high precision is required and the temperature does not fluctuate heavily.

Two point calibration:

The pH-electrode is calibrated with 2 buffer solutions. The exact characteristic curve is determined. The program calculates the deviation from the ideal characteristic curve (see diagram B).

- This calibration is recommended if the pH value or the temperature of the process solution fluctuates heavily and high precision is required.

Diagram A

Single point-calibration
with buffer pH7.00

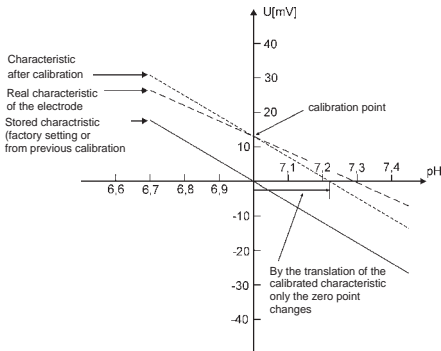
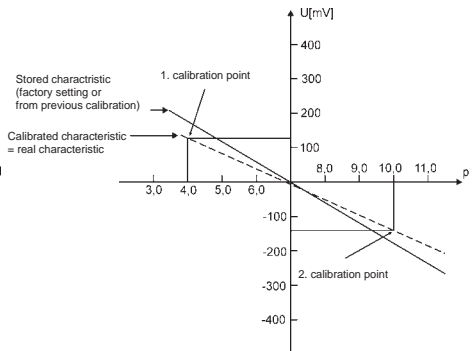

Diagram B

Two point-calibration
with buffer pH4.01 and pH10.00



Calibration modes of the UNICON-pH

1.) Automatic calibration (parameter 3 = Auto)

Using one of the standardised pH buffer solutions sets listed in the technical data (page 2) the UNICON-pH automatically calculates the parameters of the connected pH electrode. The automatic calibration can be accomplished only with sensors with integrated temperature sensor. Parameter 51 must be set to Pt100 or Pt1000

In this calibration mode also with aged pH electrodes the used buffer will be recognized, if their zero-point may not have shifted no more than ± 1.0 pH. For example, if a buffer with 4pH is used, the measured value may be in the range of 3.0 up to 5.0pH. The buffer is not recognized surely, if the measured value falls below this or exceeds this values and the automatic calibration will be stopped.

Thus the electrode did not become useless but the large deviation points to a strong aging. A manual calibration is still possible in most cases.

2.) Manual calibration (parameter 3 = Manual)

For manual calibration it is possible to choose a buffer from the standardised buffer solution sets or to enter the buffer value manually.

Manual calibration is recommend also, if the automatic calibration is not possible. In contrast to the automatic calibration during the manual calibration the buffers are not reconized automatically. Through this restriction of the maximum deviation to \pm pH1,0 is dropped. If the measurement differs more than \pm pH3,0 the electrode must be replaced.

3.) Data input (parameter 3 = Data)

The parameters zero and slope of the attaced electrode are known and entered directly.

Required solutions:

- Buffer solutions according to the desired method of calibration.
- Tap water for rinsing the electrode.

Programming

Notes to representation



Error messages

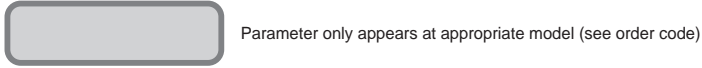

Parameter only appears at appropriate model (see order code)

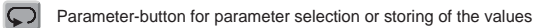

Parameter-button for parameter selection or storing of the values



Up- and Down-buttons for selection or entering values in the parameter level

Note! During the configuration only those parameters will be displayed, which are not excluded by other parameter settings or if they are available in the device.

Calibration/configuration

pH10.54 AL1☐
 25.7°C AL2■

Process value for pH- or ORP- and temperature-values
 Alarm output indication (only if activated)
 ☐ = OFF and ■ = ON.
 If collective alarm SAL is activated, the display toggles between error message and process value.



1

■Calibration
 ☐Configuration

Calibration : the connected electrode shall be calibrated.
 Configuration : the converter shall be configured.



Calibration

Configuration
 continue page 17
 parameter 39

2

■pH calibr.
 ☐ORP calibr.

This parameter only appears for model 2,
 if MR1 = pH und MR2 = ORP.



pH calibration

ORP calibration
 continue page 16
 parameter 35/36

3

Calib. ? ■Auto
 ☐Manual ☐Data

Selection of the calibration mode
 Auto : automatic buffer detection.
 Manual : manual input of the buffer values.
 Data : input of zero-point and slope.

The manual calibration is recommended for older electrodes.

Auto

Manual

Data

continue page 11
 parameter 4

continue page 13
 parameter 15

continue page 16
 parameter 33

Automatic calibration

⚠ Only for electrodes with integrated temperature sensor

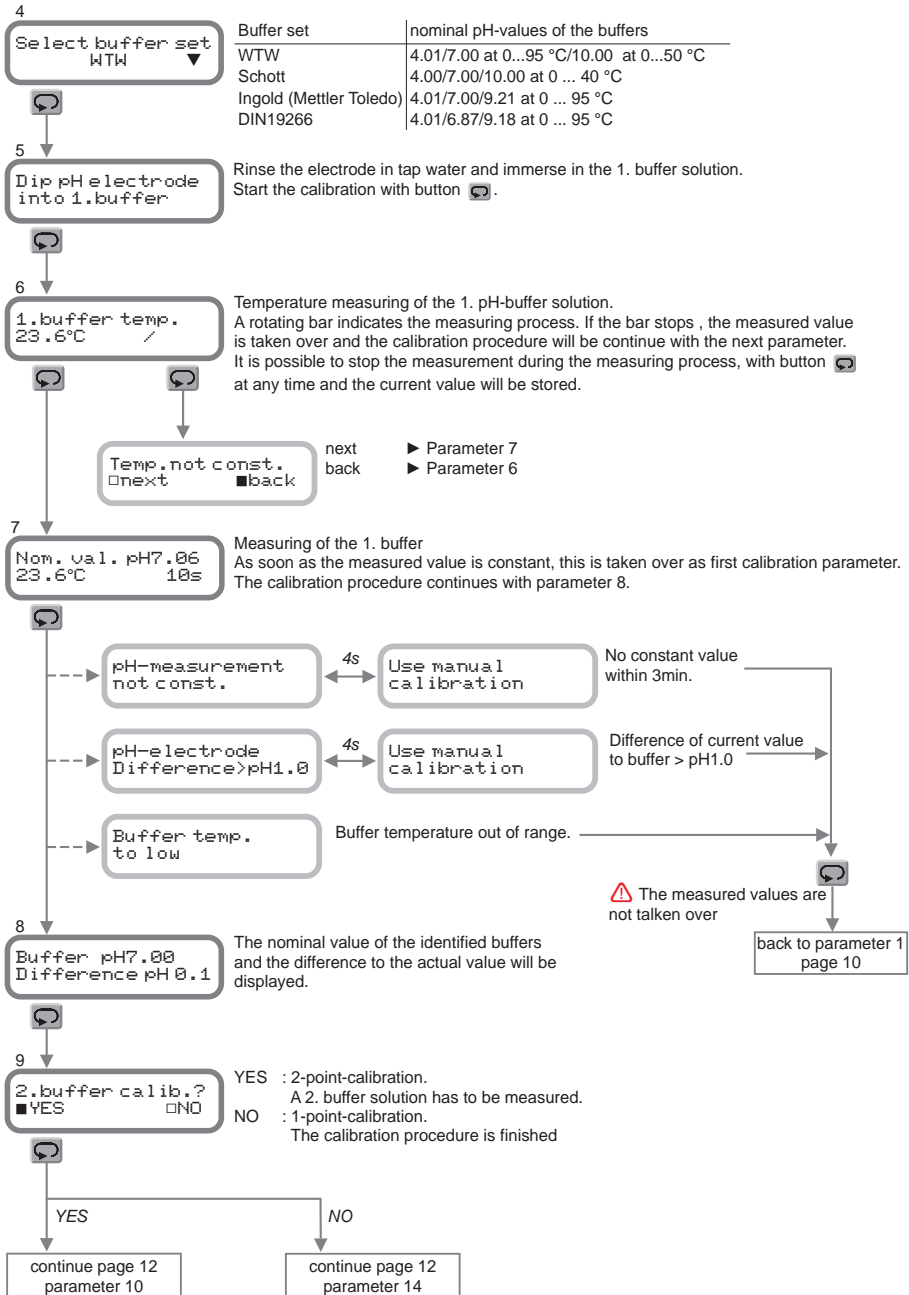

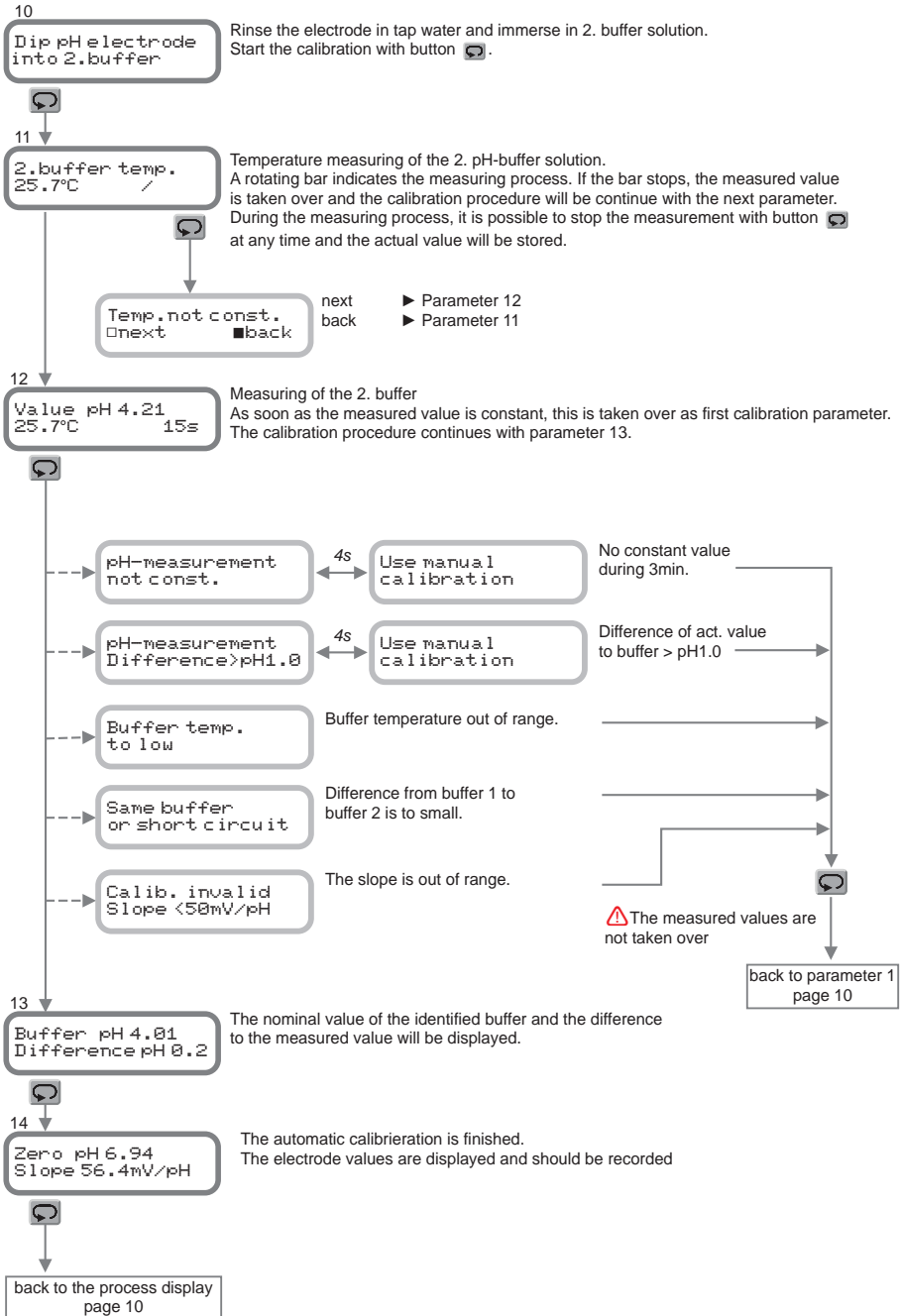

Manual calibration

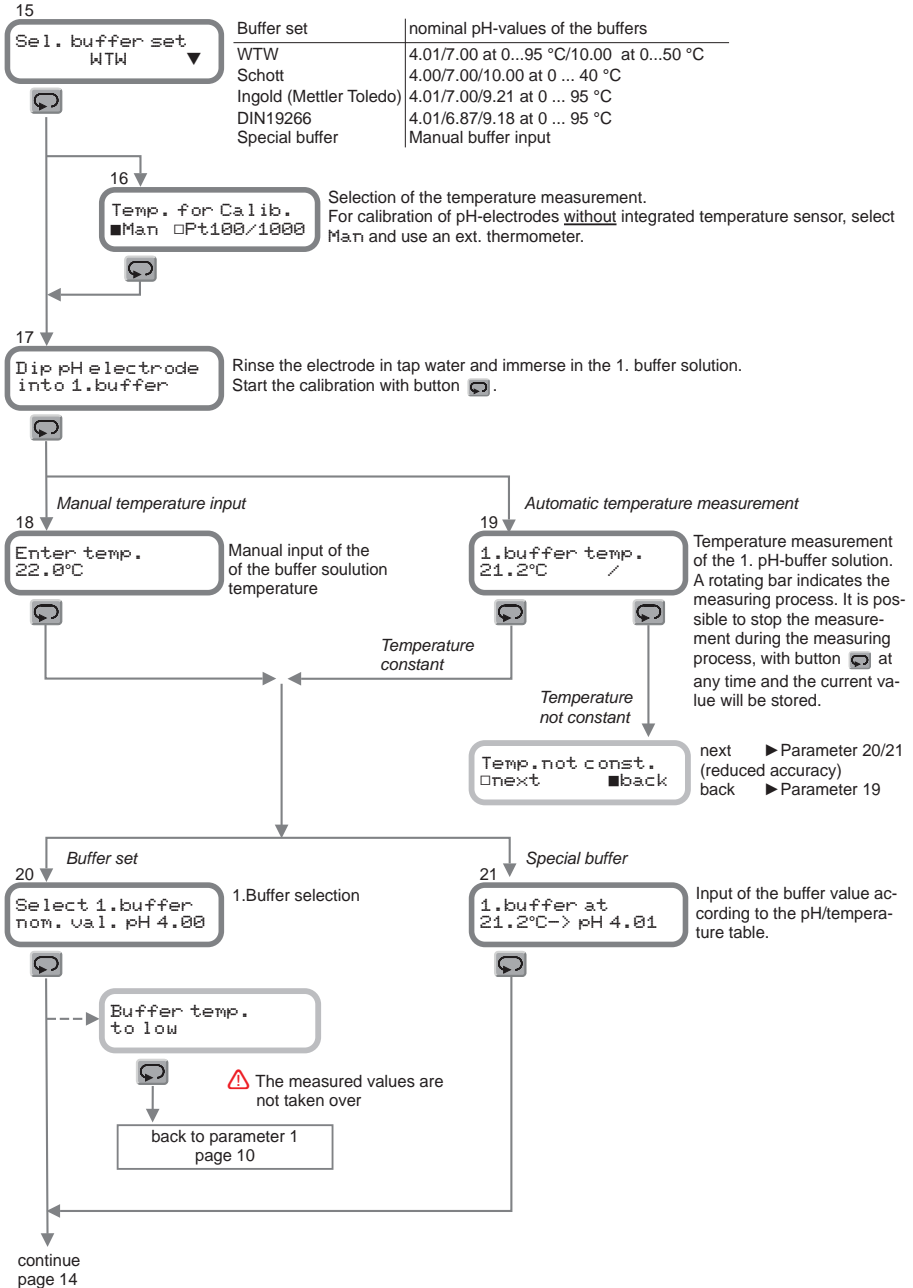

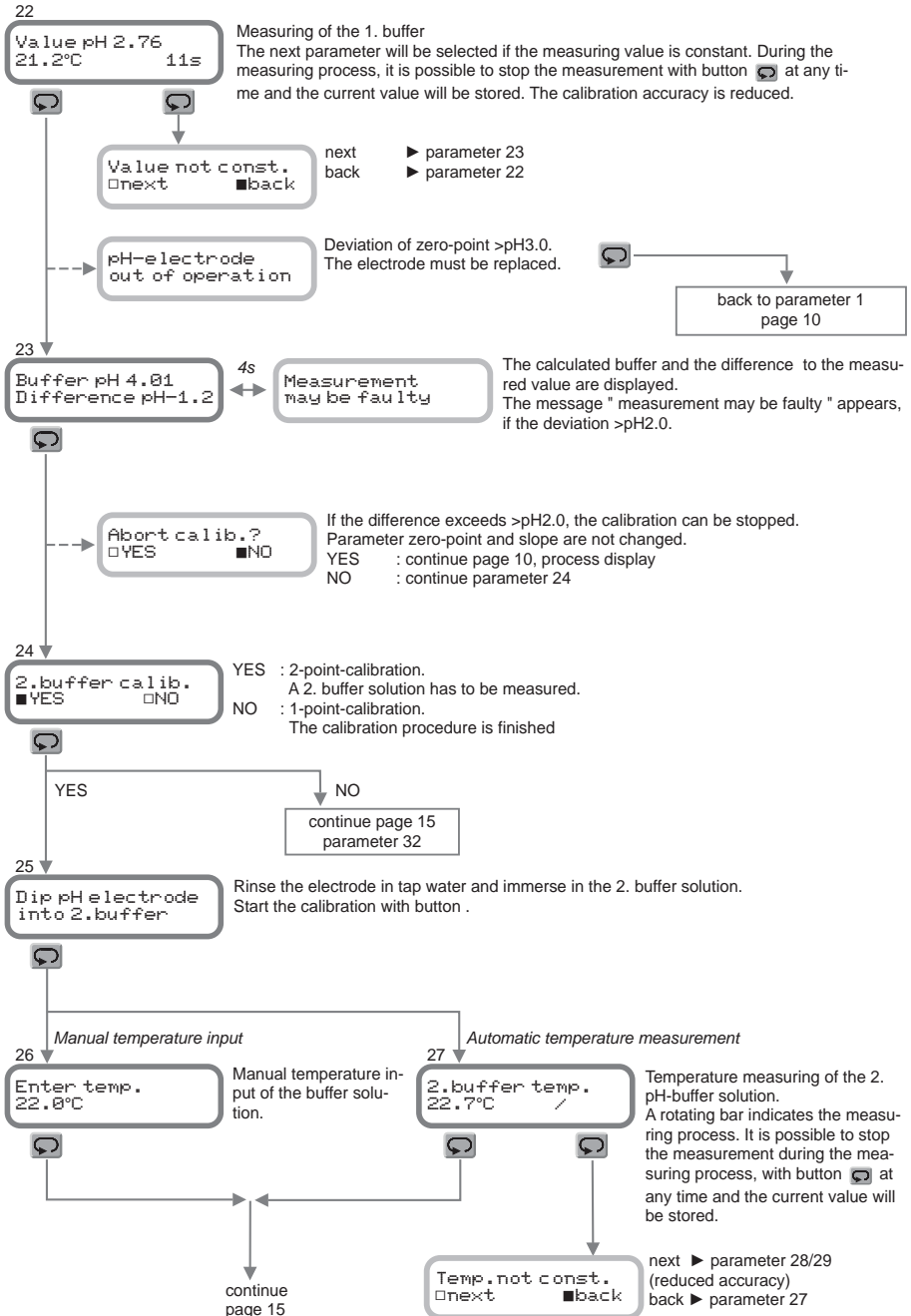

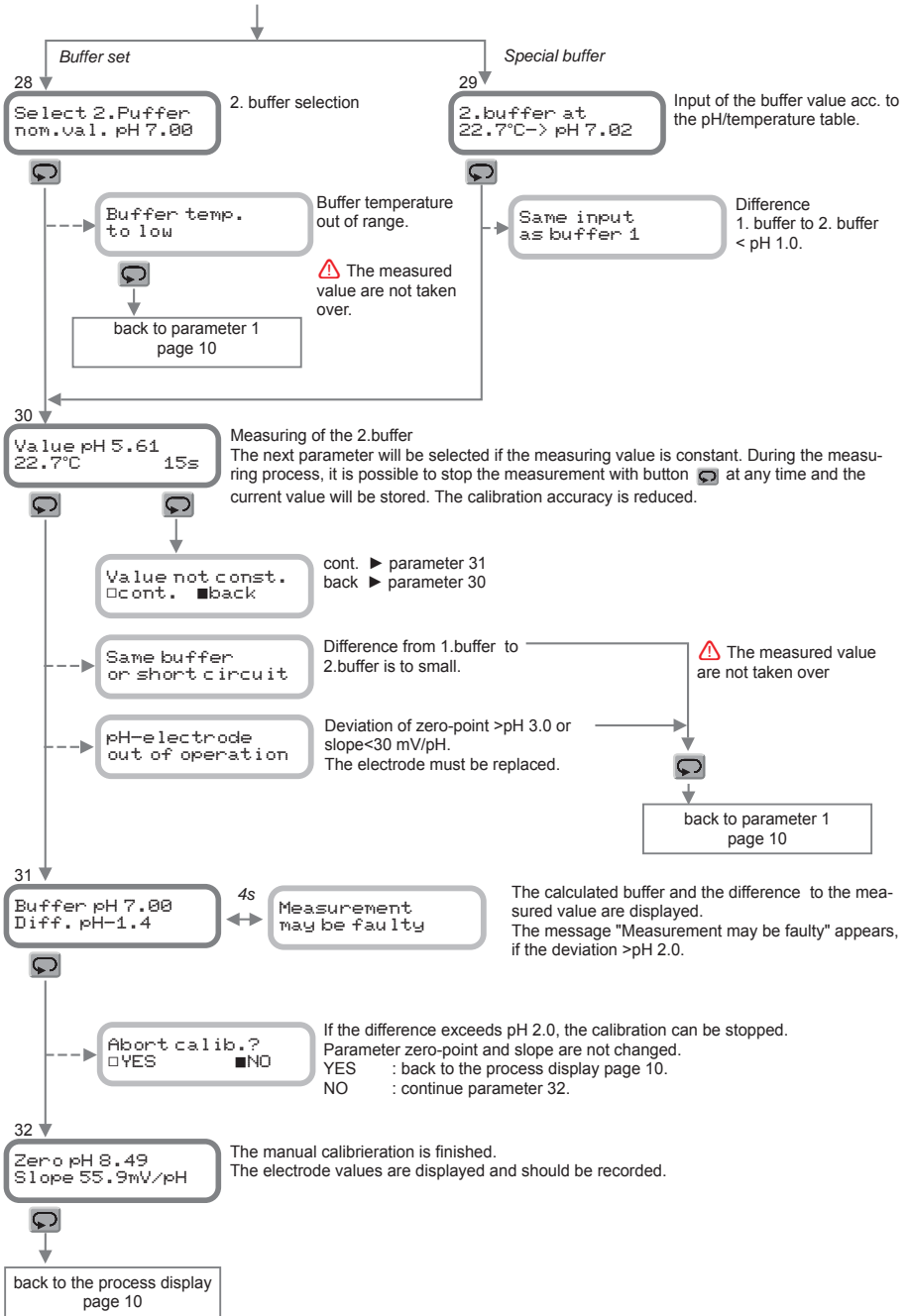

Data calibration

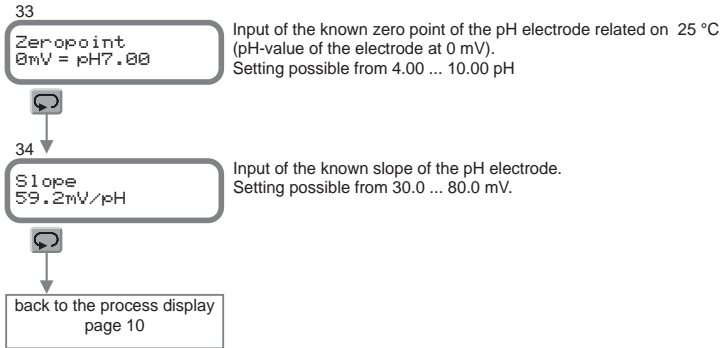

ORP calibration

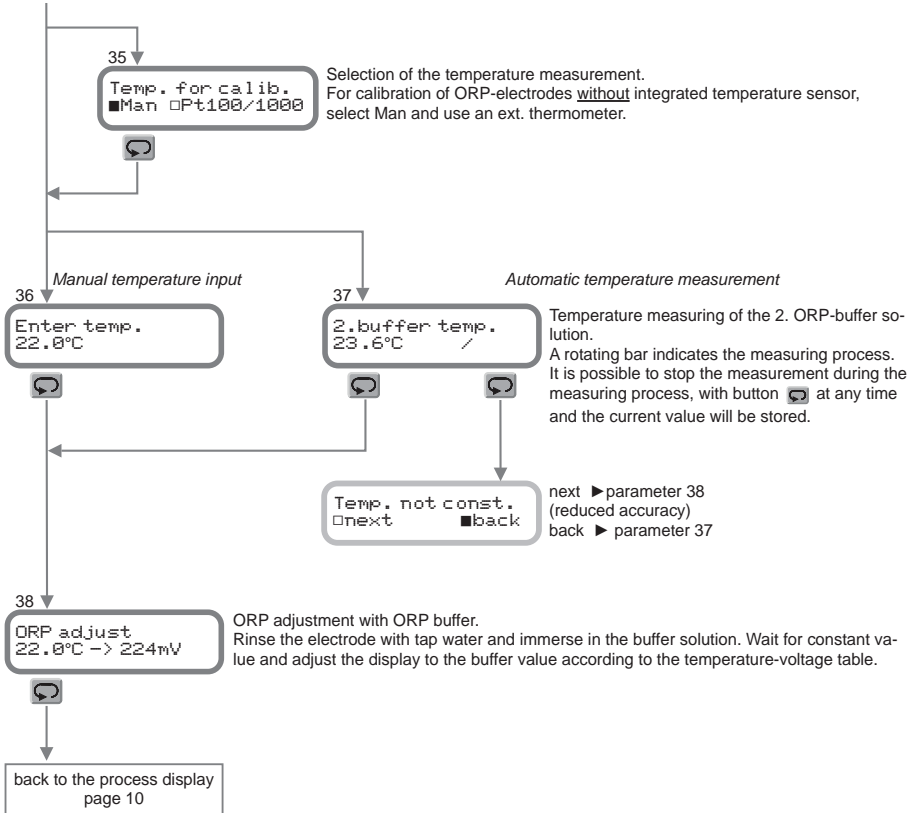

Configuration

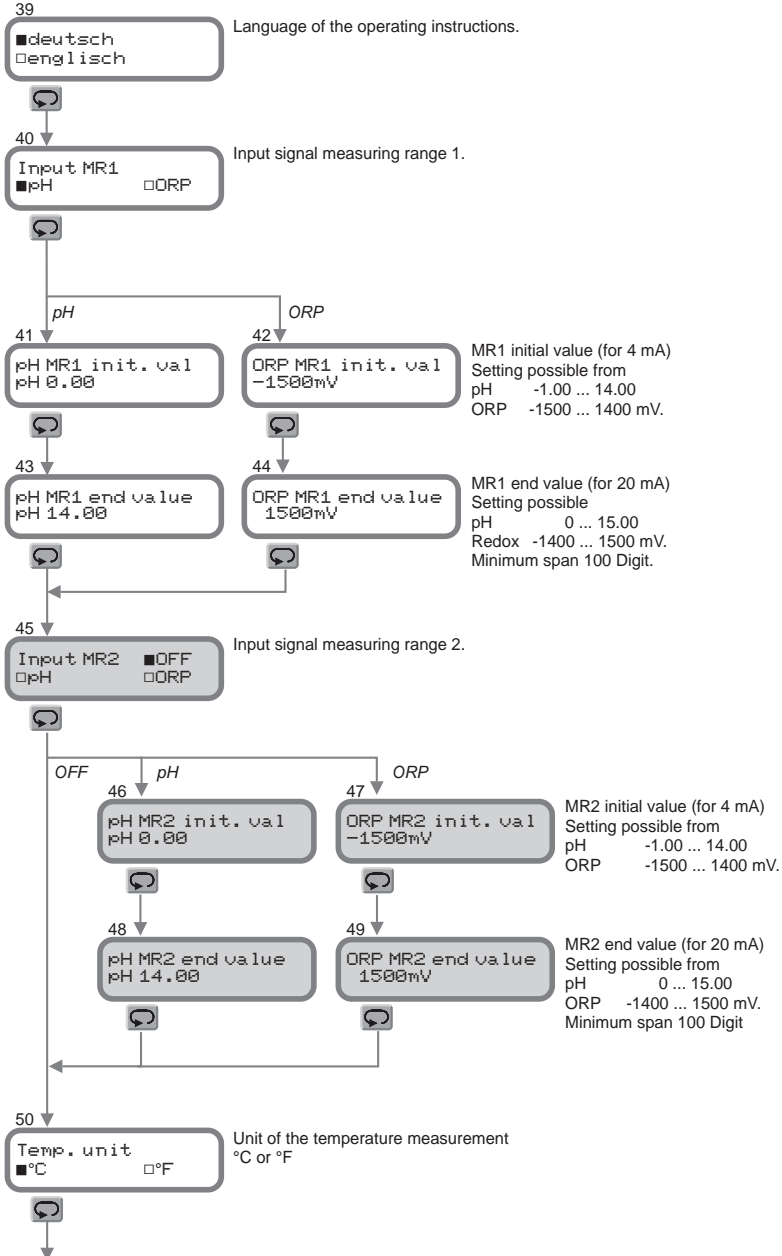

continue
page 18

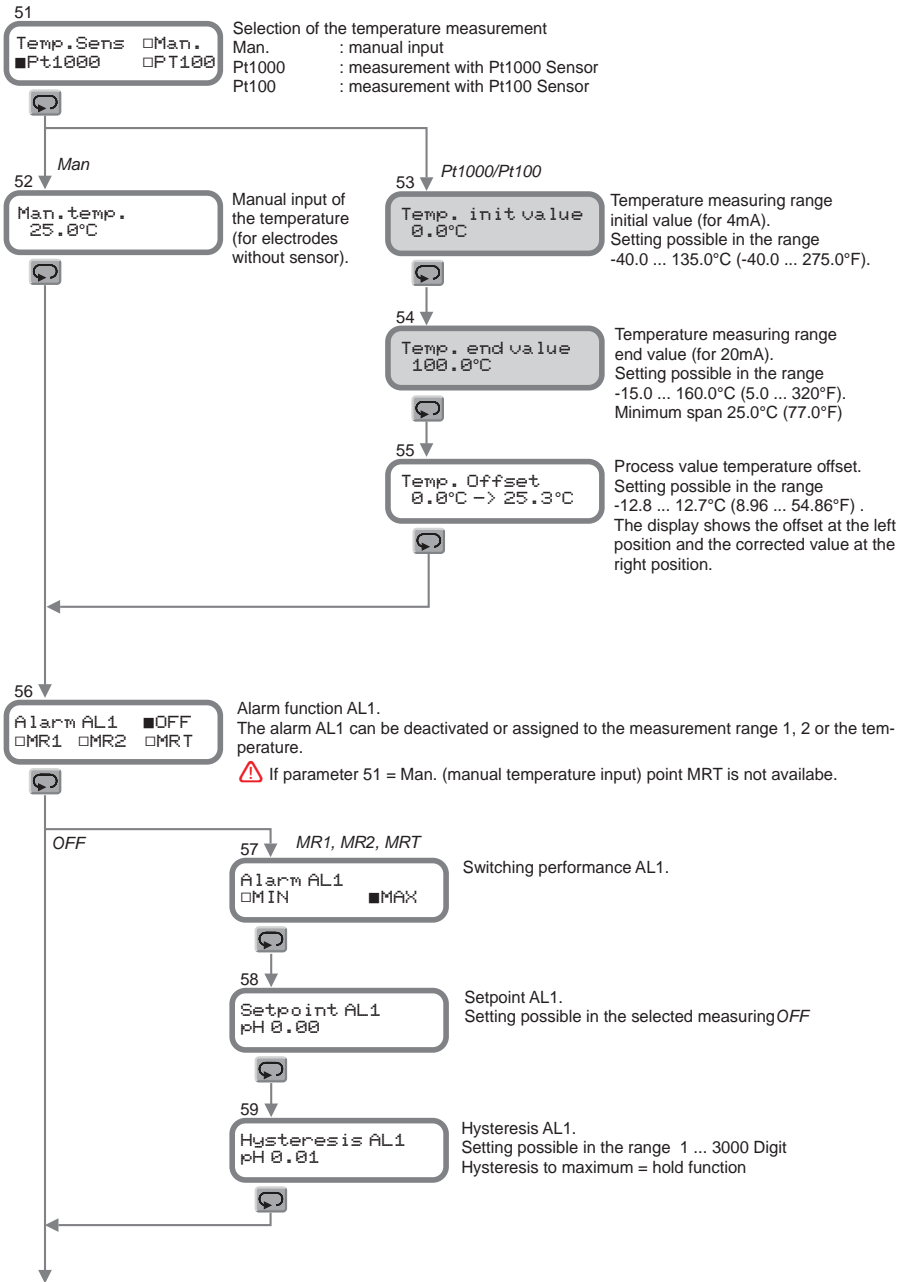

continue
 page 19

60

Alarm AL2 OFF
 MR1 MR2 SAL

Alarm function AL2.

The alarm AL2 can be deactivated or assigned to the measurement range 1 or 2 or to collective alarm (SAL).

⚠ Settings for switching performance, setpoint and hysteresis of the alarm outputs are identical for AL1 and AL2 if MR1 or MR2 is selected.



Collective alarm

If an error occurs the depending alarm-message is displayed in the process display.

61

MAX glass imped.
 OFF ON

Monitoring of the maximum glass impedance (for example break of wire).



62

Glasimp. 38MΩ
 SetpointMAX 200MΩ

Setpoint of the maximum glass impedance.

The currently measured impedance of the glass electrode is displayed in the first line.

The second line displays the setpoint (MAX Point)

Setting possible in the range 1...1000 MΩ



63

MIN glass imped.
 OFF ON

Monitoring of the minimum glass impedance (for example shorted line or break of glass).



64

Glasimp. 38MΩ
 SetpointMIN 5MΩ

Setpoint of the minimum glass impedance.

The currently measured impedance of the glass electrode is displayed in the first line. The

second line displays the setpoint (MIN Point)

Setting possible in the range 1...1000 MΩ. It is recommended to program a 1/5 of the measured impedance



65

MAX ref. imp.
 OFF ON

Monitoring of the maximum reference impedance

(only possible with connected liquid ground).

Monitoring of dirty diaphragm.



66

Ref imp. 9.8kΩ
 SetpointMAX 50.0kΩ

Setpoint of the maximum reference impedance.

The currently measured impedance of the glass electrode is displayed in the first line. The

second line displays the setpoint (Max Point)

Setting possible in the range 0.1...100.0 kΩ. It is recommended to program 5-times the value of the measured impedance.



67

Calib. interval
 100Tg-> 50T

Monitoring of the calibration interval.

Setting possible from OFF, 1 ... 1000 days.

Left area shows calibration interval.

Right area shows the remaining days of the interval.



continue
 page 20

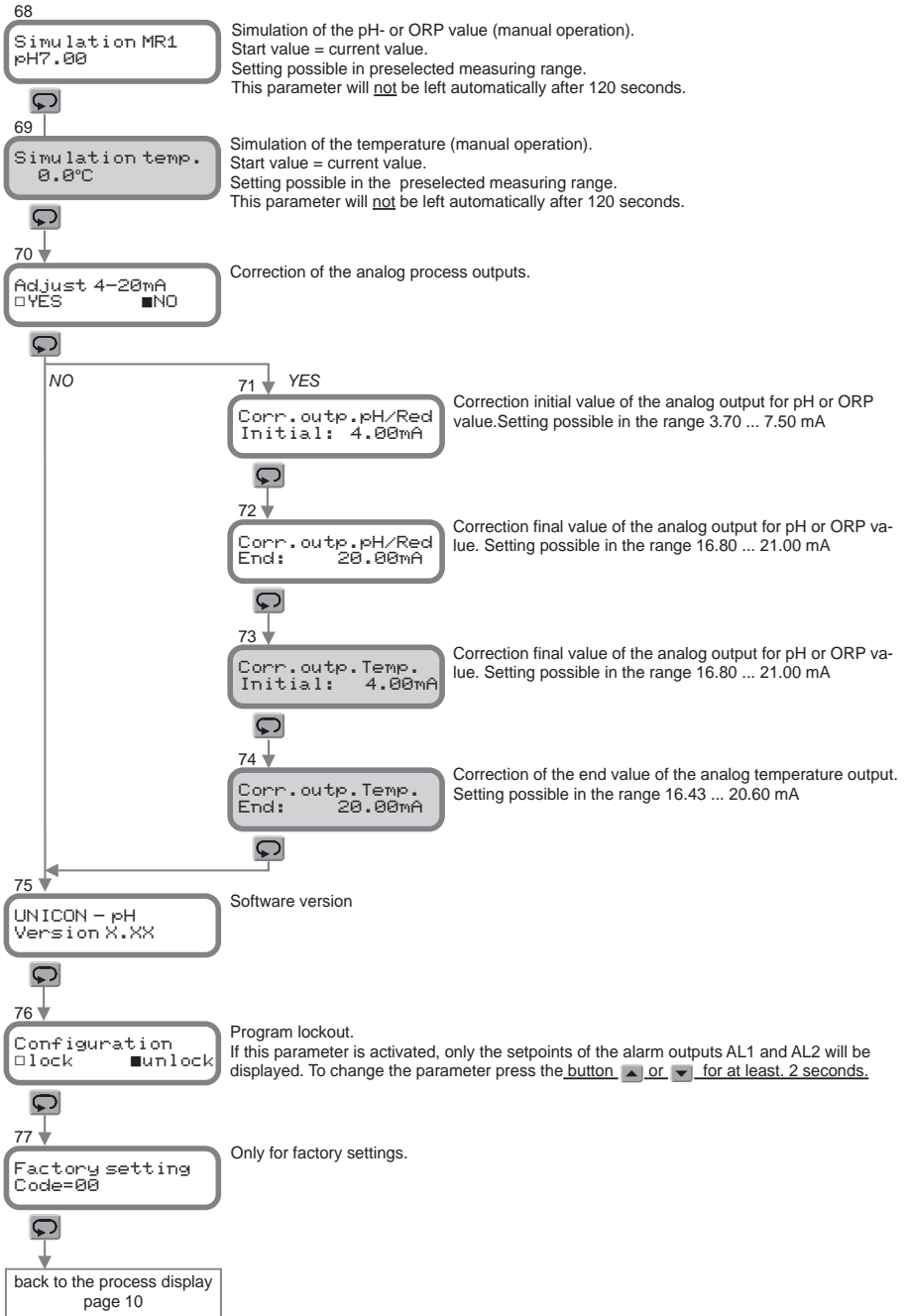

Error messages

Error! Factory check necessary

Memory error.
Factory check is necessary

Write protect !!

A changed parameter setting cannot be stored, because the write protection is activated by intern slide switch in position 1. Set the switch to position 0 and modify settings again.

Transm. error
RAM<->EEPROM

An error has occurred in the data transfer from the controller to the EEPROM, or the data in the EEPROM are damaged .

after 2 seconds

Transm. error
for Init RAM

With the button  a new initialisation of the EEPROM can be triggered. The factory and calibration settings get lost. The converter works with a reduced precision and should be new calibrated in the factory. All programmed values get lost.

Reset

UNICON - pH
Version X.XX

The converter triggers an internal reset. An attempt is made to read data from the EEPROM.

Mounting notes

Basically its recommended that there is no air between the active area of the electrode and the measuring solution. While installing a system with UNICON-pH head mounting, it may be necessary to turn converter and fitting against each other for easy operation and better reading of the display. These assembly variations are possible in steps of 30°.

In order to turn the case against the fitting position, please proceed as follows:

- ① Open the converter by releasing the 4 cover screws..
- ② Unscrew the nut of the connection converter and fitting

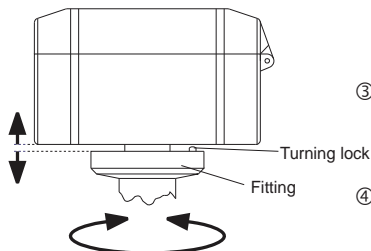
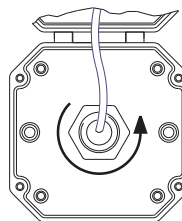

- ③ Separate the converter from fitting and place it in the desired Position. Please make sure that the turning lock will click in none of the holes
- ④ Tighten the nut of the connection converter and fitting.

Replacement of electrodes in fittings for head mounting.

pH- and ORP electrodes have a limited life. For replacement operate as follows:

- ① Open the converter by releasing the 4 cover screws.
- ② Disconnect connection cable (SMEK-6-K or S7-K) from the terminals 11-17 on the circuit board.
- ③ Unscrew the body of the fitting and head-adaptor.
- ④ Remove the screwed plug of the connection cable from the electrode.
- ⑤ Unscrew the electrode out of the fitting with a spanner (SW17).

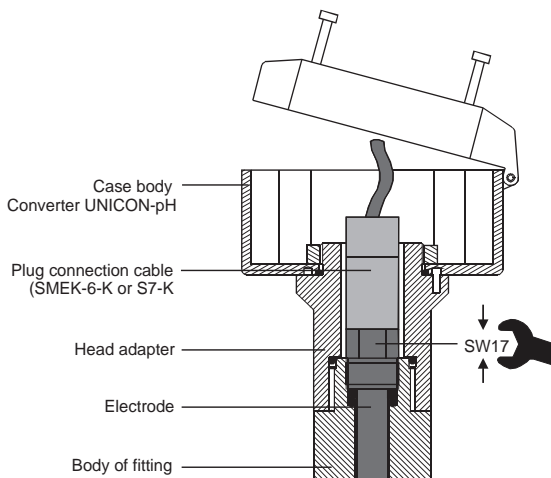

Operating Instruction for pH/ORP- electrodes

Delivery and shipping

The electrodes are supplied with a protection cap filled with a 3-mole KCl-storage solution. This cap prevents a draining of the electrode.

Storage

The electrodes should be stored within the temperature range $-5...+30$ °C. Otherwise they can be damaged irreparably, by temperatures under -5 °C. In order to avoid a draining of the electrodes, these should be stored with the associated protective cap. With longer storage time, the level of liquid of the cap is to be examined. A storage time longer than 1 year is not recommendable.

Refreshing

Dried electrodes normally can be regenerated, but they will never achieve the original conditions. Therefore the electrode must be stored in a 3-mole KCl-solution for 24 hours. If the electrode should bring thereafter still no satisfying values, a heating up to $60-80$ ° in a water bath can cleanse a possibly blocked up diaphragm. The electrodes with liquid reference must be filled up.

Preparing for Measurement

During adjustment of the cable length, the black insulating of the coax lead must be removed.
 pH-electrodes have a high internal resistance. Humidity at the connection plug must be avoided (danger; creeping current). Don't touch the contacts of the plug while removing the plug protection cap. Transition resistance lead to an erroneous measurement.
 Take off the Protection cap and rinse off possible salt incrustations. Electrodes with liquid electrolyte for the reference electrode must be possibly refilled. Electrodes with gel filling may not be opened, protecting covers may not be shifted. If there are some bubbles at the front measuring area, they are removable by shaking the electrode (like a fibre thermometer).

Calibration

In practice the characteristic curves of the pH electrode deviate from the ideal line. For precise measurement it is necessary to calibrate the pH-electrode during commissioning and after regular time intervals.
 It is common to calibrate the electrode with a 2-point-calibration for zero-point and the slope.
 The value of the buffer-solution should be nearly at the measuring value of the process. For higher precision it is recommended to heat the solution to the process temperature. Alkaline buffer change their value while picking up CO2 from the air. Acid buffer are ideal because they have a higher stability. For the best result it's recommend to calibrate with buffer-solution pH4.00 and pH7.00. The buffer solutions should be used only once.
 Before dipping the electrode into the buffer solution, it must be rinsed with water and dabbed with clean fleece cloth. Each pollution of the buffer solution can change their value, and worsen the accuracy of the calibration.

Mounting

It is very important to mount the electrode immediately before starting up the system, to protect the electrode against drainage.
 For the mounting it necessary to use a 17mm ring- or mouth spanner. Other tools will damage the glass protection sheath.

Mounting pos.

The mounting direction should be in range 10° and 170° from the vertical position

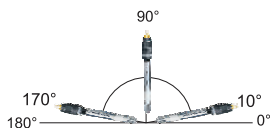

YES

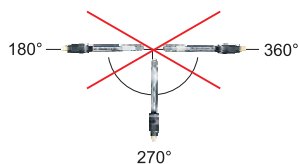

NO

Cleaning and maintenance

Dirty electrodes supply incorrect results of measurement. Therefore they should be cleaned in regular intervals. In order not to damage the electrodes, the glass diaphragm should not be scratched or scouring agents treated.

- rough contamination are dabbed with a fleece cloth.
- oily and greasy contamination are eliminated with household cleaner (no scrubbing means).
- calcifying are solved by diluted hydrochloric acid.
- Protein contamination are solved with hydrochloric acid and pepsin mixture.
- contamination of sulfide can be separated in a mixture from hydrochloric acid and thiourea.

Ordering code

UNICON-pH - 1. - 2. - 3. - 4. -

1. Model

- 1 Output 4 ...20 mA, 2-wire loop powered for pH- und ORP, 2 transistor alarm outputs, supply voltage 14 ... 30 V DC,
- 2 as 1, but additional 2. measuring range for pH and ORP, output temperature 4 ... 20 mA, 2-wire loop powered, monitoring impedance of the glass and reference electrode and the calibration interval as well.

2. Mounting

- 01 Head mounting
Assembly of the UNICON-pH directly on the fitting of the electrode
Connection of the electrode with a separate connection cable SMEK-6K (see separate data sheet)

- 02 Field mounting

Note: In-line fittings, combination electrodes and connection cable must be ordered separately (see separate data sheet)

3. Reference system

- 3 all systems with electrode zero point pH 7.00 e.g. silver/silver chloride (Ag/AgCl)

4. Temperature measurement

- 13 Pt1000/Pt100 Sensor via software selectable

Further information about pH- and ORP-measuring systems

- combination pH- and ORP electrodes
- Pt1000 temperature sensor
- in-line fittings
- accessories for conductivity and pH/ORP measurement

please contact us.