

flow **level** **temperature** **pressure**

Universal use as threshold alarm or/and transmitter.

The system comprises identical components for the various parameters in compact dimensions.

The advantages:

- two switching points
- 4(0)..20mA analogue output
- hysteresis selectable in magnitude and direction
- graphical LCD display (increased temperature range, illuminated, units in the display, incl. super-bright signalling LED)
- dialogue messages in the display
- programming ring (can be operated when wearing protective gloves)
- programming protection by turning through 180° or by removing programming ring
- stainless steel housing
- mineral glass (tempered, scratch and breakage proof) for covering the display
- M12x1 connector system
- system mounting to all HONSBERG primary sensors (rotatable)
- compact dimensions
- IP 67



2x NPN and PNP switches :

- Push pull driver offers easy set up. You set the interface as a PNP and it is a PNP. You connect it as a NPN and it is a NPN switch. Without any program settings !
- Independent hysteresis of switch 1 and 2.
- Two point regulator possible.
- Short circuit and reverse power protected.

4(0)...20mA output :

- The 3 wire design offers a 0..10V output, too.
- Programmable span for best fit to the application.
- Select 4 or 0...20mA with the parameter setting at the sensor (program ring).

flashing LED :

- Additional bright indicator, to read messages on the display.

graphic LCD display :

- Guarantee of best human interface and flexibility.
- Illuminated transparent-reflex design. Even good contrast in bright sun or in darkness.
- Best temperature range (-20...+70°C).
- Select units for US or European market.

Stainless steel housing with toughened glass front :

- Small (diameter 35mm) and rugged design, even for outdoor applications.
- IP 67
- Easy to keep the instrument clean (flush front)!
- Head can be turned for alignment after installation. A mechanical block limits the total range turnable of 360°.

program ring :

- No weak parts (as touch panels, potentiometers ...) to enter parameters
- Manual lock by turning the ring (easy!)



SYSTEM OF INSTRUMENTS

Switching points can be set directly on site with these sensors for upward and downward excursions of process values. Using the display this setting can also be carried out without the process. The momentary values at the measuring point are always visible and all the important parameters can be called up at the point of measurement (this saves time during installation and set-up and when trouble-shooting in your process). The analogue current signal can be evaluated over long distances and the momentary value made available remotely. The sensor is configured to your specification. It is therefore immediately ready for use without you having to do any programming. If you need to change parameters, then you can do this directly on the sensor with the programming ring without any additional device or tool.

The complete omni Sensor Range is formed in an extremely modular way using a kit system (hardware and software). A 16-bit microcontroller with a 14-bit A/D converter and a 12-bit D/A converter provides the necessary processing speed and measurement accuracy. The signal is displayed with units using a back-lit LCD graphical display and converted to a 4(0)..20mA signal. Two switching points with alternatively a PNP or NPN output can be programmed over the complete range.

The switching point hystereses can be set separately in value and direction (min./max. switching value). Upward and downward crossings of switching points and error messages are shown in the display with a flashing red LED, easily visible at a distance, as well as a message.

Omni-converter



Other parameters can be changed using a code:

Signal filter, selectable unit (bar, psi ...) incl. automatic conversion of the values, selectable 0 or 4..20mA output, value assignment of 4(0) and 20 mA (setting of zero point and span).

The complete housing can be rotated about the mechanical connection so that the correct reading position can be set after sealing.

During commissioning the sensor supports a **simulation mode** of the analog signal. It is possible to create a programmable mA value related to the support signal. The range is **0..20 mA**. Doing so the user may test the connection between sensors and electronic. Correction by **Code 311**.

Customer related **0 calibration** with pressure sensors. Customer programs 0 bar and selects the automatic 0 correction by **Code 211**. The Sensor shifts the total diagramm related to new 0 position.

OVERRIDDING OF OUTPUT WILL BE DETECTED, INDICATED ON DISPLAY AND THE OUTPUT.

With this sensor particular attention has been paid to ease of use. Operation occurs in a dialogue with the display messages (this small sensor can also be set when wearing protective gloves if necessary).

Reset to factory setting possible by code 989.

The combination options of the omni transducer

The omni transducer is usable with a variety of mechanical sensor systems for flow, level, temperature and pressure. This has generated a sensor family which may serve miscellaneous applications.

HANDLING AND OPERATION

The program ring can be geared into pos.1 or pos.2 the following performances can be selected:

Display of parameters with Pos. 1









- Switching points S 1 and S 2: Switching points in the selected unit.
- Hysteresis direction of S1 and S2:
Max = Hysteresis under S1 or S2
Min = Hysteresis above S1 or S2
- Hysteresis Hyst 1 and Hyst 2:
Hysteresis values of the switching points in the selected unit.
- Code:
After entering the code 111 other parameters can be set (should only occur if necessary):
- Filter: Selectable filter constant in s (affects display and output).
- Units: e.g. bar or psi ...
- Output: 0..20mA or 4..20mA
- 4 (0) mA: Value specification for 4 (0) mA
- 20mA: Value specification for 20mA

Editing with Pos. 2

- Turn the ring gap to Pos. 2 and a flashing "cursor" appears showing the position to be changed. By repeated turning to Pos. 2 the values are increased and by turning to Pos. 1 you obtain the next position. Each position can be edited in this way. If no action is made within 5 s, the device returns to the normal display section without the change being accepted.

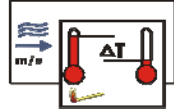
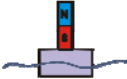
Saving the change with Pos. 1

- Turning 1x to Pos. 1 after quitting the last value signifies acceptance of the change.

combination		
flow	piston inline design	
	rotor	
	turbine	
	gear wheel	
	calorimetric	
level	float	
	ultrasonic	
temperature	PT100	
pressure differential-pressure	strain-gauge measuring bridge	



The programming ring can be swivelled to Pos. ① and Pos. ②. The following are actions possible:

Programming protection:

- The programming ring can be pulled off, turned through 180° and replaced. Then programming is no longer possible on turning the ring further.

TECHNICAL DATA

supply voltage	typically 18..30V (see separate data sheets)
power consumption	typically <1W (see separate data sheets)
measurement ranges	see separate data sheets
accuracy	typically 1% FS (see separate data sheets)
reproducibility	typically 0,1% FS (see separate data sheets)
operating temperature	-20..70°C
storage temperature	-20..80°C
signal output	4(0)-20mA, 2(0)-10V through 500 Ohm termination resistance
switching points S1 and S2	PNP or NPN selectable, 300mA load in sum max., programmable as min. or max. value, short-circuit proof, reverse-polarity proof
hysteresis	adjustable, position of hysteresis depends on min or max.
display	graphical LCD display extended temperature range -20 ... 70°C, 32x16 pixels, back-lit, shows value and units, LED signalling lamp with simultaneous message in display.
connection	at locking plug M 12x1, 5-pole
Schutzart	IP 67
material	see separate data sheets

DIMENSION

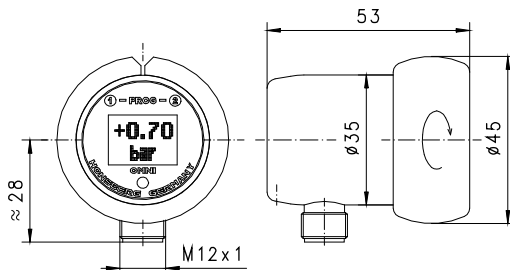

TERMINAL ASSIGNMENT

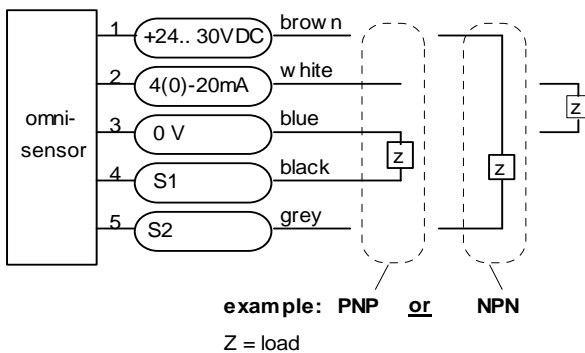

The switchpoints are changing to PNP or NPN depending to your Bitte benutzen interface automatically. Please you use shielded cable, signal lines < 30m and power supply lines < 10m.

MOUNTING

Please refer to the separate sensor description

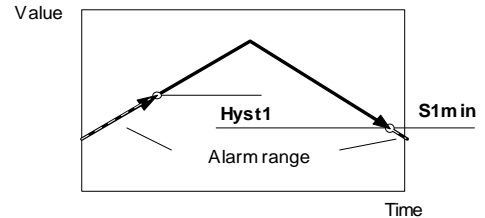
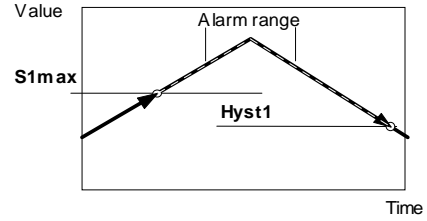

Example of hysteresis setting: S1 as max. switching point and as min. switching point) :



The omni calibration ring with integrated magnet is responsible for the functional detection of the instrument.

By position the central partition of the ring to pos.1 or 2 a test signal is activated. The neutral position is the centre between pos. 1 +2

principle:

- Pos.1 = look or next step
- Pos.2 = modification



For detailed description please apply for full omni-catalogue.