

Operating manual

Temperature measuring
transducer

MU125



Company / brands of GHM



www.ghm-messtechnik.de

Save for later reference.

Table of contents	Page
1. Intended use (areas of application)	3
1.1 Safety signs and symbols	3
1.2 Safety instructions.....	4
1.3 Product liability and warranty	4
1.4 Standards and directives.....	4
2. Product description	5
2.1. Scope of delivery.....	5
2.2. Functional principle	6
2.3. Connection diagram	6
2.4. PowerRail	7
2.5. Type plate	8
3. Assembly and installation	9
3.1. Mechanical assembly.....	9
3.2. Electrical installation.....	9
4. Functional description	10
4.1 Controls.....	10
4.2 Service mode	12
4.21 Check of factory settings.....	12
4.22 Output characteristic curve specification.....	13
4.23 Current simulation	15
5. Commissioning, maintenance and service	16
5.1 Commissioning.....	16
5.2 Maintenance.....	16
5.3 Service	16
6. Technical data	17
6.1 Mechanical design / dimensions	19
7. Order code	20
8. Device transport and storage	20
9. Return to manufacturer	21
10. Disposal	21
11 Imprint	21
12. Certificate of Conformity	22

1. Intended use (areas of application)



Refer to the chapter 'Product description' for detailed specifications for the area of application.

The operational safety of the device is only assured when used as intended in accordance with the specifications in the operating manual.

Intervention beyond the actions described in the operating manual may only be carried out by personnel authorised by the manufacturer for safety and warranty reasons. Conversions or modifications made on one's own authority are expressly prohibited.

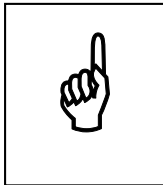

Application-specific dangers can emanate from this device when used improperly or not as intended.

The device is **not** suitable for use in explosion-prone areas.



General safety instructions, use

This operating manual must be kept in a location such that qualified personnel can refer to it at all times.

Any processes described in this operating manual may only be carried out by trained, qualified personnel who are authorised by the owner and wearing protective clothing. All rights reserved.

1.1 Safety signs and symbols

Warning notices are identified in this document as described under Table 1:

 Danger	Warning! This symbol warns of imminent danger which can result in death, severe bodily injury, or severe property damage in case of non-observance.
	Attention! This symbol warns of potential dangers or harmful situations which can cause damage to the device or to the environment in case of non-observance.
	Note! This symbol indicates processes which can have a direct influence on operation or can trigger an unforeseen reaction in case of non-observance.

1.2 Safety instructions

Read the product description before commissioning the device. Ensure that there are no limitations for use of the product for the relevant applications.



The owner is responsible for ensuring the fault-free operation of the device. The owner is obligated to ensure compliance and to observe the required work and safety measures of the current applicable regulations for the entire duration of use.

1.3 Product liability and warranty

Exclusion of liability:

The contents of the operating manual have been checked to ensure conformity with the described device. However, deviations cannot be entirely ruled out. Therefore, we cannot assume any guarantee for complete conformity. The specifications in this document are checked regularly and any necessary corrections are incorporated into subsequent versions. This document is subject to technical changes. In addition, all claims are based on the valid 'Standard Terms for the Supply of Products and Services of the Electrical Industry'.

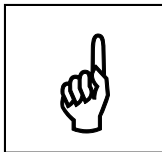

GHM Messtechnik cannot inspect or repair any devices without the required form having been filled in completely (see chapter "Return").

1.4 Standards and directives

Low-voltage Directive 2014/35/EU
Testing standard 60664-1: 2007

EMC Directive 2014/30/EU
Testing standard EN 61326-1: 2013

RoHS Directive 2011/65/EU
Testing standard EN50581: 2012

(Issue years for testing standards belong to german versions)

2. Product description

Temperature measuring transducers of the series MU125 convert a temperature measurement value or resistance measurement value from various sensors to a current signal of 4..20mA.

The universal configurability of the measuring inputs reduces the stock requirement for various applications.

The measuring inputs and the analog output are galvanically isolated.

The housing width of only 12.5mm enables space-saving installation in the switch cabinet.

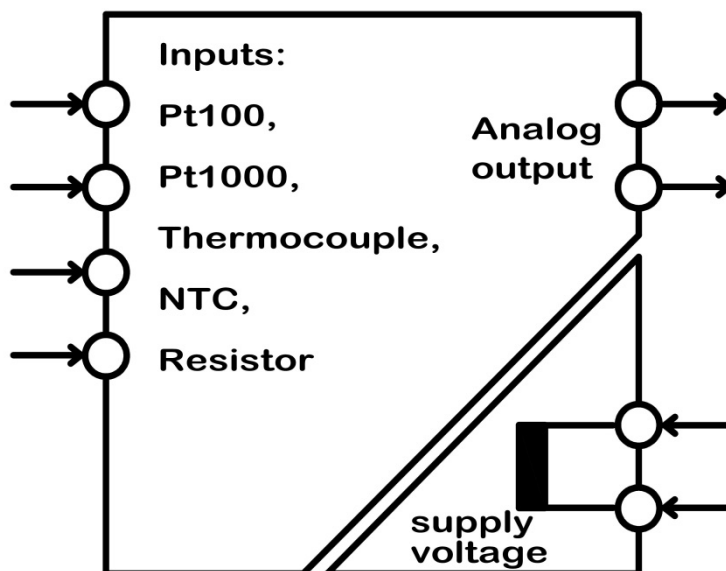

2.1. Scope of delivery

- MU125
- This operating manual
- Additional documents, if applicable

2.2. Functional principle

An analog output value with 4..20 mA is actuated depending on the selected measuring range.

The temperature measuring ranges are linearised.

The device configuration is carried out with DIP switches.

The device can be supplied in a wide range between 20..125V DC or 20..253V AC.

A low cost version with 24V DC power supply is available.

Another version allows a 24V power supply via a mounting rail bus (Power Rail)

2.3. Connection diagram

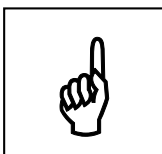
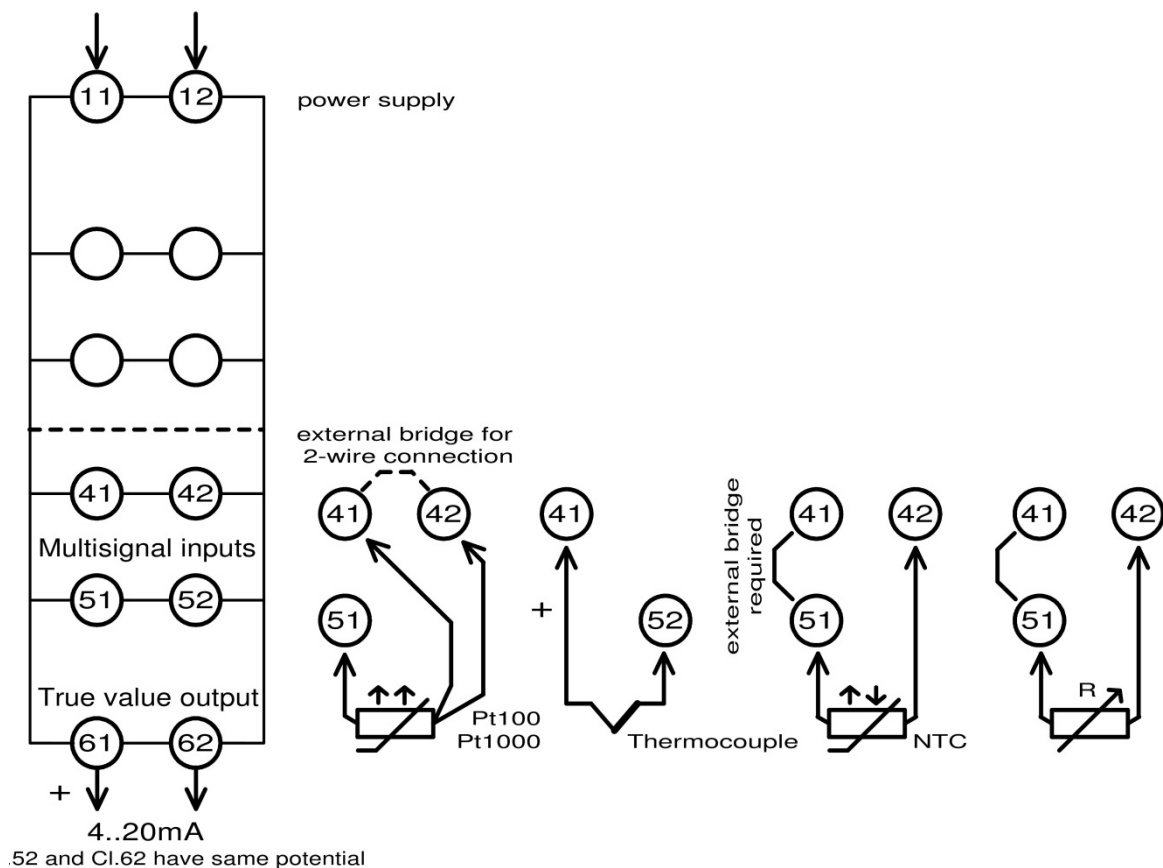

The input signal should be connected via separate two-wire or three-wire conductors. Earthed conductors can cause faults at an analog actual value output that is not galvanically isolated.

2.4. PowerRail

The supply of multiple devices can be combined and simplified via a bus system in the carrier rail (TS35).

A corresponding version is available for the entire LP series of GHM carrier rail devices in a housing with 12.5 mm width.

A bus adapter compatible with series connection is clamped on the carrier rail before installation of the device to be supplied with power.

An adapter is required for each device. The bus power supply is provided via a plug-type terminal strip.

The power supply terminals 11 and 12 on the upper device side are omitted in device version MU125LP designed for this purpose.

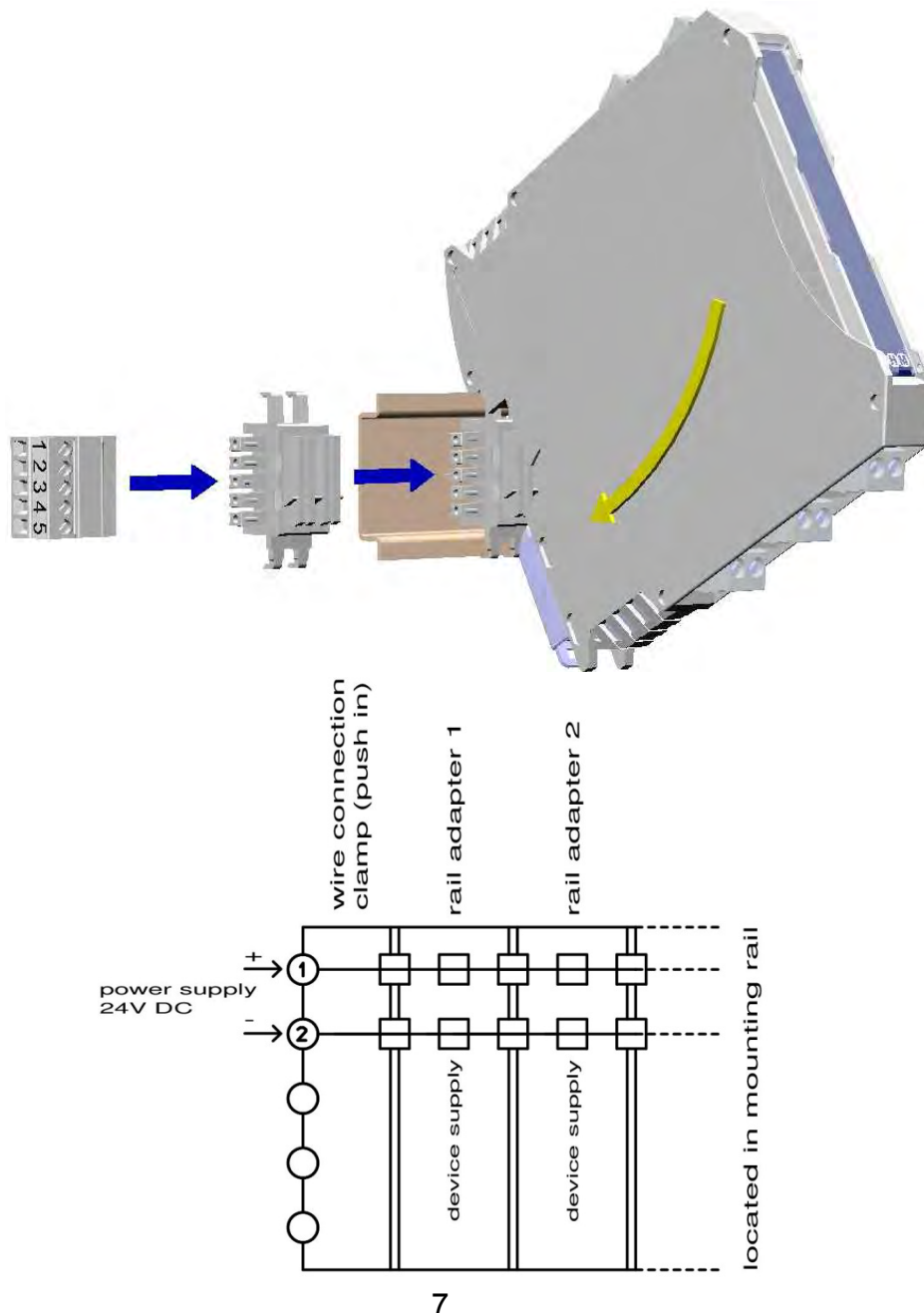

2.5. Type plate

The type plate provides the most important identification data

- Type and article designation
- Technical data
- Serial number / bar code

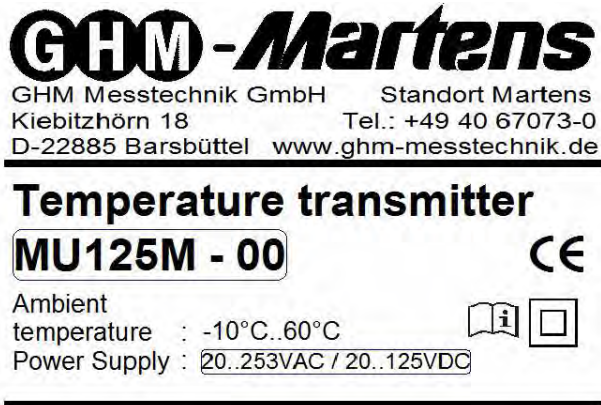

Fig. 3: Type plate

3. Assembly and installation

3.1. Mechanical assembly

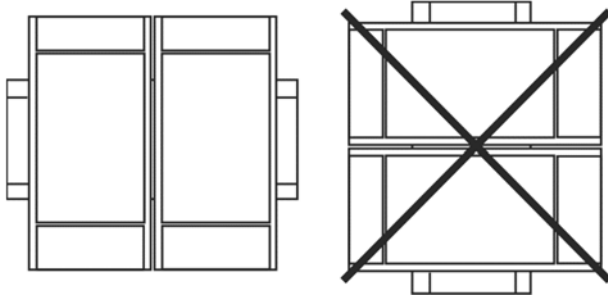

Fig. 4

Carrier rail mounting TS35, DIN EN 60715

The gapless installation of multiple devices is only possible with a horizontally installed carrier rail.

3.2. Electrical installation



The device may only be installed by an electrician. Compliance with the national and international regulations for installation of electrical and electronic systems applicable in the respective country of use is mandatory.

Voltage supply in accordance with DIN EN60664-1, SELV, PELV.

Observe the connection diagram for installation of inputs and outputs.

The supply voltage connection is made at connections 11 and 12 of the plug-type terminal strip.

Terminals 41, 42, 51 and 52 are provided for sensor connection

Terminals 61 and 62 are provided for analog true value output

4. Functional description

4.1 Controls

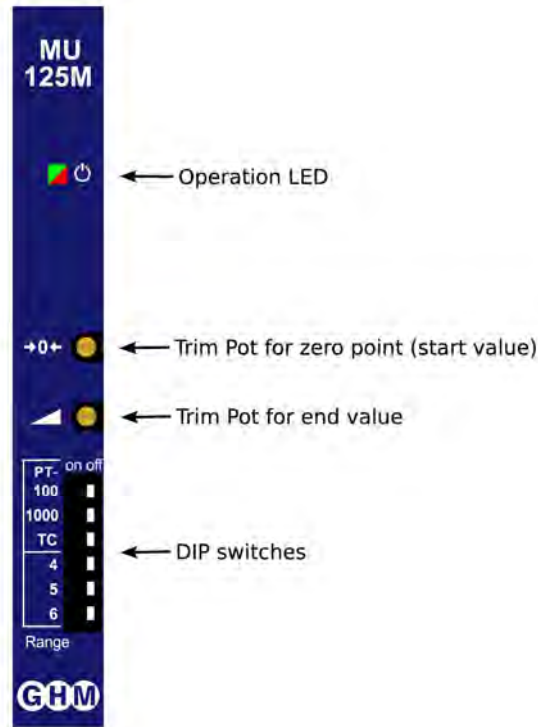

Operation LED states

- Green continuous light: Normal operation.
- Red slow blinking (one-second frequency): Errors at the measuring inputs

In service mode

- Red continuous light: The trim potentiometer is positioned at the factory setting.
(red light differs from normal operation)
- Red rapid blinking: Position of the trim potentiometer is positioned above the calibrated factory setting.
Turn anti-clockwise to reach the factory setting.
- Green rapid blinking: Position of the trim potentiometer is positioned below the calibrated factory setting.
Turn clockwise to reach the factory setting.

The measuring range is selected with the DIP switches:
Pt100, Pt1000, thermocouple (type J, type K, type S), NTC and linear resistance.

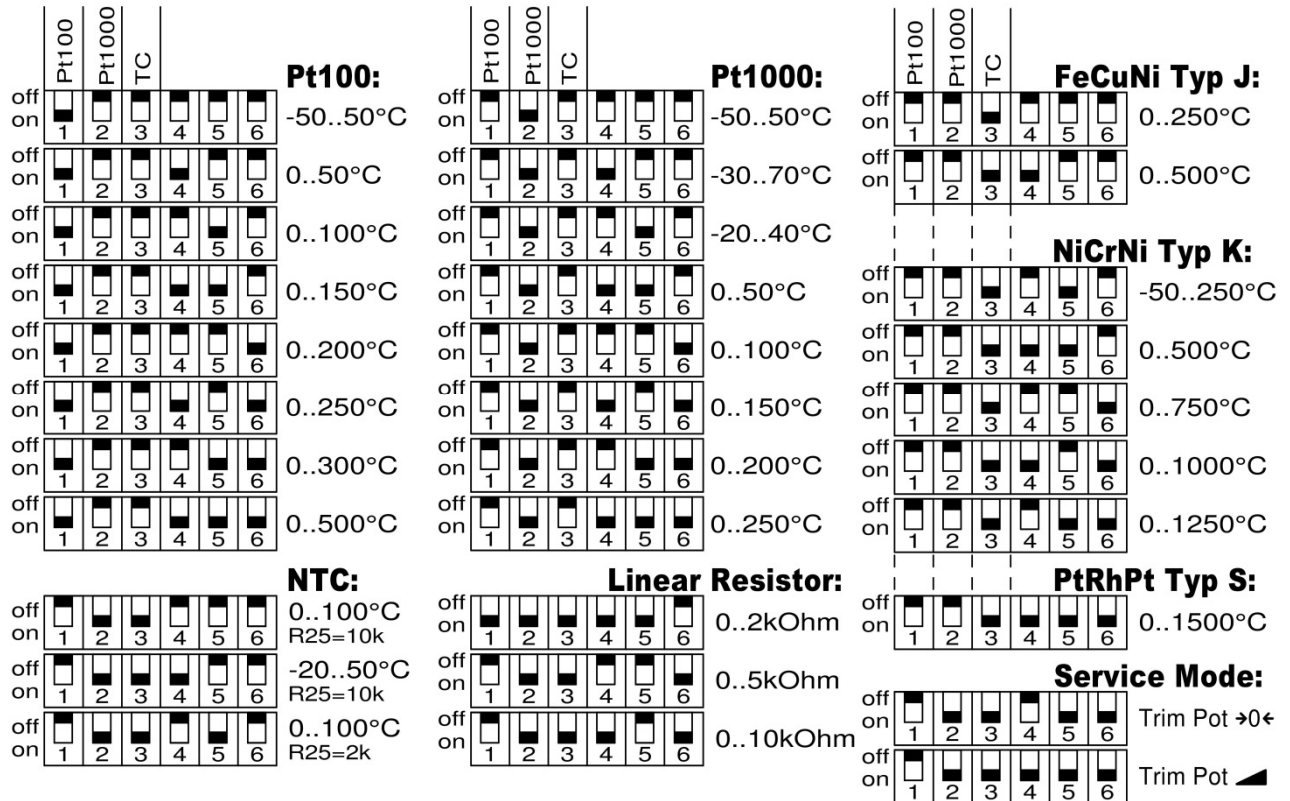

The black fields symbolise the position of the DIP switch

Sensor break and sensor short circuit

Monitoring for sensor breaks and short circuits also takes place in the measuring ranges for Pt100 and Pt1000 sensors.

In this case, the relays become inactive and the scale light blinks red.

The analog output drops to approx. 0mA.

Trim potentiometer

The 12-turn trim potentiometer can

▲ reduce the end value by 50%

and

→0← change the zero point (start value) by +/- 40% based on the factory measuring range
(= factory end value - factory start value)

There is also a service mode for the trim potentiometer offering the following possibilities:

- a) A check of whether potentiometers are positioned at the calibrated factory settings
- b) The pre-adjustment of a new output characteristic curve with connection of a current measuring device. (A temperature calibrator is not necessary)
- c) Specification of a constant value at the current output, e.g. in order to test the reaction of connection devices.

The trim potentiometers can be used in both normal operation and service mode.

4.2 Service mode

A corresponding service mode can be selected for each of the two trim potentiometers via the DIP switches.

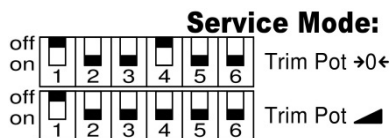

4.21 Check of factory settings

- If the selected potentiometer is positioned at the calibrated factory setting, the operation LED illuminates **red (continuously)**.
- If the potentiometer is above the calibrated factory setting, the operation LED blinks **red**.
- If the potentiometer is below the calibrated factory setting, the operation LED blinks **green**.
(Since the end value can only be reduced, the green blinking is omitted)

4.22 Output characteristic curve specification

Settings for a deviating measuring range can be made without using a temperature calibrator

For this purpose, the respective **trim potentiometer is coupled directly to the analog output** and generates a current proportional to the setting.

Value range

The current output can basically generate a current in the range of 4..20mA. The current range is thus 16mA. (20mA minus 4mA)

As a result, the following classifications arise for a current change:

A change of the input signal by	100%	50%	40%	30%	20%	10%	1%
results in an output voltage change of	16mA	8mA	6.4mA	4.8mA	3.2mA	1.6mA	0.16mA

The position of the assigned trim potentiometer simulates the input signal in the 2 service modes.

Reduction of the measuring range end value



The measuring range end value can be reduced by up to 50% below the factory end value. This process is simulated in service mode with an output current controlled by the  trim potentiometer.

Without reduction of the factory end value, which corresponds to the end position of the trim potentiometer, a constant current of **20mA** is provided at the output in service mode. The operation LED then illuminates **red** (continuous light).

The  - trim potentiometer must be turned **clockwise** *) for a reduction of the measuring range end value. The operation LED then blinks **red**.

According to the table above, for reducing the end value by

- 20% the output current must be reduced by 3,2mA down to 16,8mA
- 50% the output current must be reduced by 8mA down to 12mA

*) The clockwise rotation is based on the behaviour in normal measuring operation: The output current based on the actual value increases with clockwise rotation, but this results in a smaller measuring range.

Change of the measuring range start value

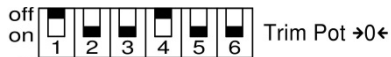

The start value can be changed by +/-40% based on the factory measuring range (= factor end value - factor start value).

In order to show the potential change of the start value on the output current range, a virtual zero point of **12mA** *) is assumed.

This output current is generated in service mode if the →0← trim potentiometer is positioned at the calibrated factory setting.

The →0← trim potentiometer is then in the centre position. The operation LED illuminates red (continuous light).

*) If the factory zero point were based on 4mA, the output current for the simulation of a reduction by 40% would have to be negative, which is not technically possible

According to the value range table on the preceding page, for a change of the start value by

-40% the output current must be reduced by turning anticlockwise 6.4mA down to 5.6mA (12mA - 6.4mA = 5.6mA)

-10% the output current must be reduced by turning anticlockwise 1.6mA down to 10.4mA (12mA - 1.6mA = 10.4mA)

+10% the output current must be increased by turning clockwise 1.6mA up to 13.6mA (12mA + 1.6mA = 13.6mA)

+40% the output current must be increased by turning clockwise 6.4mA up to 18.4mA (12mA + 6.4mA = 18.4mA)

The operation LED blinks green with a reduction and red with an increase.

Note:

The device can only detect a minimum measurement temperature of -50°C in most measuring ranges (refer to "Technical data" for more information).

Therefore, a reduction of the start value by -40% only makes sense in the factory measuring ranges of 0..50°C, 0..100°C and -20..40°C. However, since the device can not recognise the measuring range to be applied later after leaving the service mode, a reduction by -40% can always be adjusted in this mode.

In reality the device would switch off the output if the measuring temperature is too low (approx. 0mA).

Examples

- 1) A measuring range of 0..500°C should be changed to 0..400°C.
For this purpose, the factory end value must be reduced by 20%
(1 - 400°C / 500°C = 0.20 = 20%).

The value range table on the previous page shows that in service mode a reduction of the output current by 3,2mA must take place.

Therefore, an output current of 16.8mA must be adjusted (20mA – 3.2mA = 16.8mA) in service mode by the ▲ trim potentiometer.

In service mode for the →0← trim potentiometer the factory setting of 12mA should be left.

2) A measuring range of 0..100°C should be changed to -25..60°C.

For this purpose, the measuring range end value must be reduced by 40%.

(1 - 60°C / 100°C = 0.4 = 40%)

Based on the value range table on page 13, the output current must be reduced (in service mode) by 6.4mA for a reduction of the end value by 40%.

Therefore, an output current of 13.6mA must be adjusted (20mA – 6.4mA = 13.6mA) with the  trim potentiometer.

To calculate the adjustment for the measuring range start value, the factory measuring range is determined first (factory end value - factory start value):

100°C – 0°C = 100°C. (negative start values must be added because of the double sign)

The measuring range start value should then be reduced by 25°C based on the measuring range, which then also necessitates a reduction of the output current by 25% in service mode.

This value is multiplied by the greatest possible current change of 16mA: 16mA * 25% = 4mA

Therefore, an output current of 8mA must be adjusted in service mode for the .

(virtual zero point at 12mA minus 4mA reduction = 8mA)

Accuracy

A reduction of the end value or an increase of the start value always reduces the measuring accuracy.

The (in)accuracy values specified in the "Technical data" thus increase by the factor:

$$\frac{\text{factory end value} - \text{factory start value}}{(\text{adjusted end value}) - (\text{adjusted start value})}$$
 (divided by)

(negative start values must be added because of the double sign)

4.23 Current simulation

The change of the output current proportional to the trim potentiometer setting in service mode can also be used to simulate an action which should appear in normal mode.

An output current in the range of 5.6mA to 18.4mA can be simulated with the .

The  potentiometer can simulate an output current in the range of 10mA to 20mA.

After the simulation, the potentiometers must then be turned back to the original position, i.e. the factory setting.

5. Commissioning, maintenance and service

5.1 Commissioning

1. Ensure that the connections have been made as indicated in the connection diagram and the supply voltage is correct.
2. Ensure that the terminals are firmly screwed in.
3. After switching on the power supply, check to ensure the operation.

5.2 Maintenance

Housing:

No cleaning or maintenance is required when operated as intended.

5.3 Service



Service of the device is only possible in the factory.

6. Technical data

Wide-range power supply

Supply voltage : 20..125VDC and
 20..250VAC (47..63Hz), max.1.5W

24V power supply

Supply voltage : 24V DC +/-15%, max. 1.5W

Combined data

Rated voltage- : 253V AC (in accordance with EN 60664-1; Degree of contamination 2, Overvoltage category II)
 Test voltage : 3kV AC between supply voltage // input = output
 Working temperature : -10..60°C
 Storage temperature : -20..80°C
 Air humidity : 10..90% (no condensation)
 EMC : in accordance with EN 61326-1

Measurement inputs

Pt100 : linearised,
 Measuring current approx. 1.6mA
 Pt1000 : linearised,
 Measuring current approx. 130µA
 In the event of a sensor break or short circuit, the analog output drops to 0mA. The operation LED blinks red
 Thermocouple : linearised with comparison position compensation (optionally without internal compensation)
 NTC : linearised for B_{25/85}=3977K or 3528K
 Max. load 200µW (averaged)
 Linear resistance : MR. 0..2kΩ: approx. 1.4mA
 MRs. 0..5kΩ, 0..10kΩ: approx. 300µA
 Zero point setting : +/-40% of the factory measuring range (= end value – start value) via 12-turn trim potentiometer
 End value reduction : -50% based on the factory end value via 12-turn trim potentiometer
 Potentiometer setting limits : Limitation of the aforementioned adjustment ranges

Pt100	-50..500°C	(..600°C)
Pt1000	-50..250°C	(..300°C)
FeCuNi	-100..500°C	(..800°C)
NiCrNi	-150..1250°C	
PtRhPt	0..1500°C	(..1600°C)
NTC (10kΩ)	-20..100°C	(..150°C)
NTC (2kΩ)	-40..100°C	(-50°C..150°C)
R linear	0..10kΩ	

(values in parentheses apply for optional, customer-specific special measuring ranges that are configured at the factory)

Analogue output: 4..20mA, max. burden 400Ω,
No galvanic isolation from the input signal
(max. burden error of 0.2% at 400Ohm)

	Measuring range	Basic accuracy	Temperature deviation *)
Pt100	-50.. 50°C	0.4%	0.01%/K
	0.. 50°C	0.6%	0.02%/K
	0..100°C	0.4%	0.02%/K
	0..150°C	0.4%	0.01%/K
	0..200°C	0.3%	0.01%/K
	0..250°C	0.3%	0.01%/K
	0..300°C	0.2%	0.005%/K
	0..500°C	0.2%	0.005%/K
Pt1000	-50.. 50°C	0.4%	0.01%/K
	-30.. 70°C	0.4%	0.01%/K
	-20.. 40°C	0.4%	0.01%/K
	0.. 50°C	0.6%	0.02%/K
	0..100°C	0.4%	0.02%/K
	0..150°C	0.4%	0.01%/K
	0..200°C	0.3%	0.01%/K
	0..250°C	0.3%	0.005%/K
FeCuNi	0..250°C	1.0%	0.04%/K
	0..500°C	0.5%	0.03%/K
NiCrNi	-50..250°C	0.7%	0.05%/K
	0..500°C	0.5%	0.04%/K
	0..750°C	0.4%	0.03%/K
	0..1000°C	0.3%	0.02%/K
	0..1250°C	0.3%	0.02%/K
PtRhPt	0..1500°C	1.0%	0.04%/K
NTC R ₂₅ =10kΩ B _{25/85} =3977K	0..100°C	1.0%	0.01%/K
NTC R ₂₅ =10kΩ B _{25/85} =3977K	-20..50°C	1.5%	0.01%/K
NTC R ₂₅ =2kΩ B _{25/85} =3528K	0..100°C	1.0%	0.01%/K
Resistance linear	0.. 2kΩ	0.3%	0.005%/K
	0.. 5kΩ	0.5%	0.01%/K
	0..10kΩ	0.3%	0.005%/K

*) Measurement deviation depending on the environmental temperature in the switch cabinet (-10..+60°C)

Casing

- Dimensions (WxDxH) : 12.5 x 114 x 108 mm
- Material : PA6.6, light grey, Flammability class V0 (UL94)
- Weight : 120 g
- Protection rating : IP20
- Screw terminals : 0.2..2.5 mm², AWG 24 - 14, removable, coded
- Push-in terminals : 0.5..1.5 mm², AWG 25 - 16, double connection
(12A between the connections),
removable, coded
- Power Rail : 8A over the entire bus system
(power supply via removable terminals
0.2..2.5 mm², AWG 24..14)

6.1 Mechanical design / dimensions

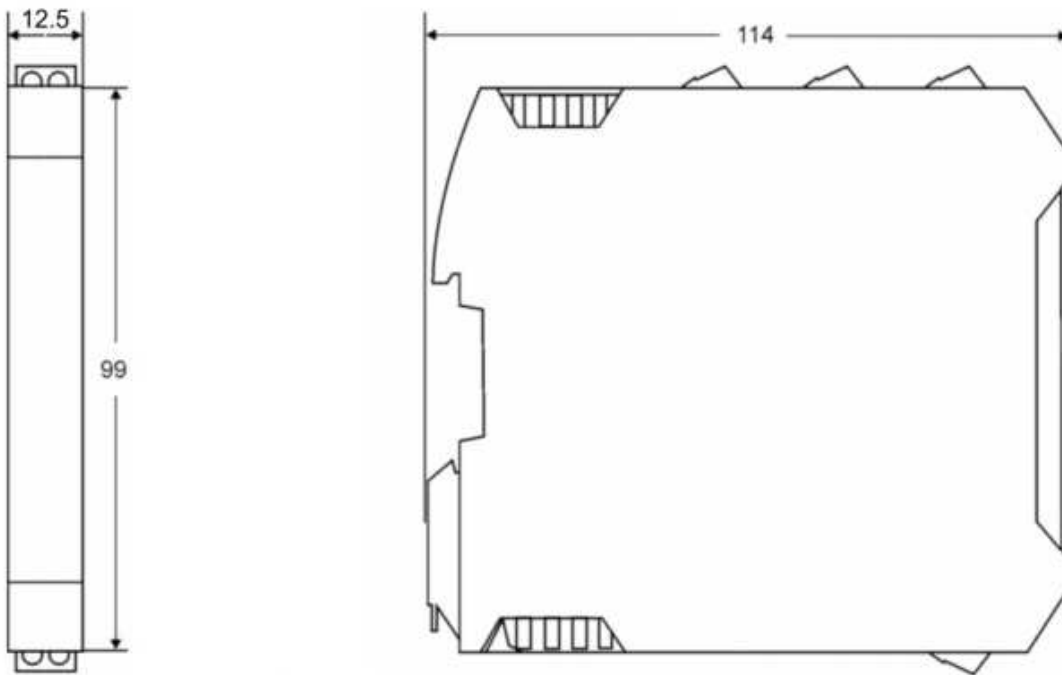

7. Order code

MU -

1.	Device version	
	125L	Supply voltage 24V DC +/- 15%
	125LP	Supply voltage:24V DC +/- 15% with carrier rail bus connection *)
	125M	Wide-range power supply 20..125VDC / 20..253V AC
4.	Options	
	00	No options
	01	Push-in terminals (plug-in)

*) Delivery incl. suitable bus adapter, see also chapter "PowerRail"

8. Device transport and storage

Gentle and tension-free packaging of the housing must be ensured for transport (no machine wrapping of the package).

The device must be stored in the environmental conditions specified in the technical data.

9. Return to manufacturer



The legal regulations for environmental protection and our personnel require that devices which are sent back which have come into contact with liquid are handled without risk to people or the environment.

If you send a device back to us for inspection or repair, we must request that you strictly observe the following requirements:

On the GHM homepage under: 'Downloads/forms' a return shipment form can be downloaded.

The repair can be performed quickly and without call-back questions if:

1. a filled-in form is provided for each device,
2. the device has been cleaned and packaging which prevents damage to the device is used, and
3. a safety data sheet for the measuring medium is affixed to the outside of the package, if the device has come into contact with a critical substance.

10. Disposal



Separation by material and recycling of device components and packaging must take place when the device is disposed of. The valid legal regulations and directives applicable at the time must be observed.

The device may not be disposed of with household waste. If the device should be disposed of, return it to us with the return shipment form filled in under the chapter "Return". We will then arrange for the proper disposal.

11 Imprint

GHM Messtechnik GmbH
Standort Martens, Kiebitzhörn 18, 22885 Barsbüttel, Germany
Managing Director: Günther Oehler
Registered office: Schloßstr. 6, 88453 Erolzheim / Germany
Amtsgericht Ulm, Commercial Register Section B 730462

Copyright: GHM Messtechnik GmbH. All rights reserved. Reprints, digital use of any type, and duplication may only take place with the written authorisation of GHM Messtechnik GmbH.

12. Certificate of Conformity

... professionelle Messtechnik „MADE IN GERMANY“



EU-KONFORMITÄTSERKLÄRUNG EU-DECLARATION OF CONFORMITY

GHM Messtechnik GmbH Standort Martens, Kiebitzhörn 18, 22885 Barsbüttel, Germany

Dokument-Nr. / Monat.Jahr: **3048 / 04.2016**
Document-No. / Month.Year:

Wir erklären hiermit als Hersteller in alleiniger Verantwortung, dass die folgenden Produkte konform sind mit den Schutzziele der Richtlinie des Europäischen Parlaments:
We declare as manufacturer herewith under our sole responsibility that the following products are in compliance with the protection requirements defined in the European Council directives:

Produktbezeichnung: **MU125L / MU125LP / MU125M**
Product identifier:

Produktbeschreibung: **Temperatur-Messumformer**
Product description: **Temperature transmitter**

Die Produkte entsprechen den folgenden Europäischen Richtlinien:
The products conforms to following European Directives:

Richtlinien / Directives	
2014/30/EU	EMV Richtlinie / EMC Directive
2014/35/EU	Niederspannungsrichtlinie / Low Voltage Directive
2011/65/EU	RoHS / RoHS

Angewandte harmonisierte Normen oder angeführte technische Normen:
Applied harmonized standards or mentioned technical specifications:

Harmonisierte Normen / harmonized standards	
EN 61326-1:2013	Allgemeine EMV-Anforderungen / General EMC requirements
EN 60664-1:2007	Allgemeine Isolationsanforderungen / General isolating requirements
EN 50581:2012	Beschränkung der gefährlichen Stoffe / Restriction of hazardous substances

Diese Erklärung wird verantwortlich für den Hersteller abgegeben durch:
The manufacturer is responsible for the declaration released by:

Michael Wulf

Standortleiter
Business unit manager

Barsbüttel, 18. April 2016

Diese Erklärung bescheinigt die Übereinstimmung mit den genannten Harmonisierungsrechtsvorschriften, beinhaltet jedoch keine Zusicherung von Eigenschaften.
This declaration certifies the agreement with the harmonization legislation mentioned, contained however no warranty of characteristics.

GHM Messtechnik GmbH – Standort Martens

Kiebitzhörn 18 • 22885 Barsbüttel • Germany

Phone +49-40-670 73-0 • Fax -288

www.ghm-messtechnik.de • info@martens-elektronik.de



