

Monitoring Relay MR 50Ex

Standard signals 0/4 ... 20 mA, 0/2 ... 10 V DC



Features

- Input intrinsically safe ATEX II (1) G [Ex ia] IIC/IIB
ATEX II (1) D [Ex iaD],
standard signals 0/4 ... 20 mA, 0/2 ... 10 V DC
- Measuring range programmable
- Basic accuracy 0.1 % +/- 1 Digit
- Installed units:
mV, V, mA, A, Ω, kΩ, μS/cm, mS/cm, °C, °F, min⁻¹, rpm,
bar, mbar, hPa, mm, cm, m, %, °, l, l/min, m³, m³/h, ppm
and custom units are programmable
- Integrated transmitter supply 16 V DC max. 20 mA
- Simulator function
- Fault monitoring for break of wire
in the measuring circuit
- Programmable fault function
Analog output min. or max. overflow
Alarm outputs min. or max. function
- 2 alarm outputs (relay SPDT)
- Isolated analog output 0/4 ... 20 mA; 0/2 ... 10 V DC
- Full 3-port isolation



General

The Monitoring Relay MR50Ex offers intrinsically safe inputs (0/4 ... 20 mA and 0/2 ... 10 V DC) for sensors which are installed in the explosion endangered area. Measuring value and programmed unit are shown in the display. The integrated transmitter supply offers direct connection of loop powered sensors.

Simple programming, 2 alarm outputs (SPDT) and optional available fully isolated free programmable analog output 0/4 ... 20 mA; 0/2 ... 10 V DC meets the demand for different applications. Peak value indication for minimum and maximum measured values are stored in the background and can be read out from the display at any time.

Short information

Programming	The device is programmed by frontal buttons, in connection with the LCD display.
Inputs	Standard signal 0/4 ... 20 mA and 0/2 ... 10 V DC
Alarm outputs	The alarm outputs can be programmed as max. or min. function. Switch-on delay and switch-off delay time is programmable from 1 s up to 9 h. The switching status is displayed through LED's.
Fault function	A break of wire in the measuring circuit could be monitored. The switching function of the analog and alarm output(s) is programmable in case of an fault.

Technical data

Power supply

Supply voltage : 230 V AC $\pm 10\%$, 115 V AC $\pm 10\%$, or 24 V DC $\pm 15\%$
 U_m 253 V AC or 125 V DC
 (Terminals 11 and 13)

Power consumption : max. 5 VA

Operating temperature : -10 ... 55 °C (14 ... 131 °F)

Rated voltage : 250 V AC acc. to EN 60664-1:2007
 between input/relay output/analog output/supply voltage
 degree of pollution 2, overvoltage category III

Test voltage : 4 kV DC between input/relay output/analog output/supply voltage

CE-conformity : ATEX-directive 94/9/EG

EN 60079-0:2006 EN 60079-11:2007
 EN 61241-0:2006 EN 61241-11:2006

Standardize EN 61326-1:2013			Result
IEC 61000-4-2 (ESD) IEC 61000-4-3 (E-field) IEC 61000-4-8 (Magnetic field)	Case	4 kV/8 kV contact/air 10 V/m 30 A/m	B A dispensed with
IEC 61000-4-11 (Voltage dip) IEC 61000-4-4 (Burst) IEC 61000-4-5 (Surge) IEC 61000-4-6 (HF current feed)	AC power supply connection	0.5 period, $\pm 100\%$ 2 kV 1 kV L/N, 2 kV L,N/PE 3 V	A A A A
IEC 61000-4-4 (Burst) IEC 61000-4-5 (Surge) IEC 61000-4-6 (HF current feed)	DC power supply connection	2 kV 1 kV L/N, 2 kV L,N/PE 3 V	A A A
IEC 61000-4-4 (Burst) IEC 61000-4-5 (Surge) IEC 61000-4-6 (HF current feed)	Input/output, signal/control	1 kV 1 kV L/N/PE 3 V	A B A
CISPR11	Radiated interference		Passed

Inputs

Explosion protection :  II (1) G [Ex ia] IIC/IIB or II (1) D [Ex iaD]

Approval : TÜV 08 ATEX 554329

Standard signal : 0/4 ... 20 mA; 0/2 ... 10 V DC

Fault detection : Break of wire in the measuring circuit

Input resistance : Current input 10 Ω , voltage input 10 k Ω
 (Terminals 45, 46, 47)

Basic accuracy : $<0.1\%$, ± 1 Digit

Temperature coefficient : 0.01 %/K

Safety data

Max. voltage (no load) U_0 : 18.9 V

Max. short circuit current I_0 : 92.5 mA

Max. power consumption P_0 : 580 mW

Resistance R : 272 Ω

Characterisitic curve : trapezoidal

Internal inductivity : 4 μ H

Internal capacity : 1.2 nF

Transmitter supply : 16 V DC max. 20 mA
 (Terminal 48)

Explosion protection	Ex ia/IIC	or	ia/IIC	ia/IIB
Max. external inductivity	: 2.3 mH		0.1 mH	5 mH
Max. external capacity	: 0.12 μ F		0.22 μ F	0.76 μ F

At connecting of externally supplied active intrinsically safe circuits the rules for the interconnection of intrinsically safe circuits have to be observed.

Max. values U_i : 30 V
 I_i : 52 mA
 P_i : 980 mW

Continue page 3

Technical data

Outputs

- Alarm outputs A1-A2 : Relay SPDT < 250 V AC < 250 VA < 2 A $\cos\phi \geq 0.3$,
< 300 V DC < 40 W < 2 A
(Terminals 21, 22, 23; 25, 26, 27)
- Analog output : 0/4 ... 20 mA burden $\leq 500 \Omega$; 0/2 ... 10 V burden $> 500 \Omega$, galv. isolated,
output changes automatically (burden impedance dependent)
- Accuracy : 0.2 %; TK 0.01 %/K
For connection at electrical equipments with supply voltage of max. 230V
(Terminals 17 and 18)
- Fault function : For break of wire detection
→ Analog output 0 mA, < 3.6 mA or > 21.5 mA programmable
→ Alarm output(s) min. or max. function programmable

Display : Graphic LCD-Display 128x64 pixels, white background illuminated

Case : Polyamide (PA) 6.6, UL94V-0, DIN rail mounting TS 35

Weight : approx. 450 g

Connection : Screw terminals 0.14 ... 2.5 mm² (AWG 26 .. 14)

Protection : Case IP30, terminals IP20, German BGV A3

Connection diagram

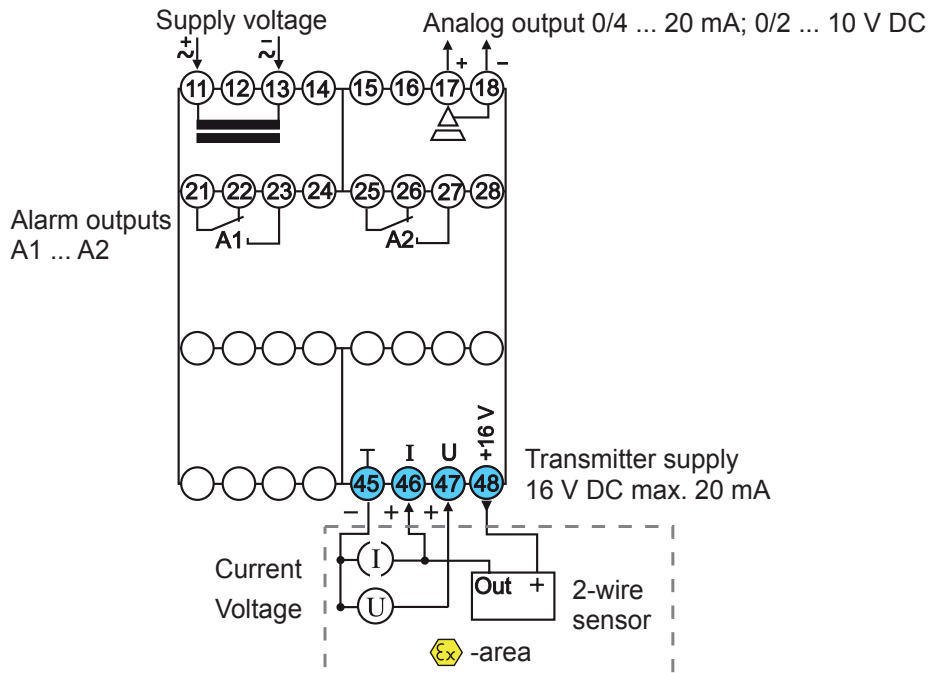

Dimensions

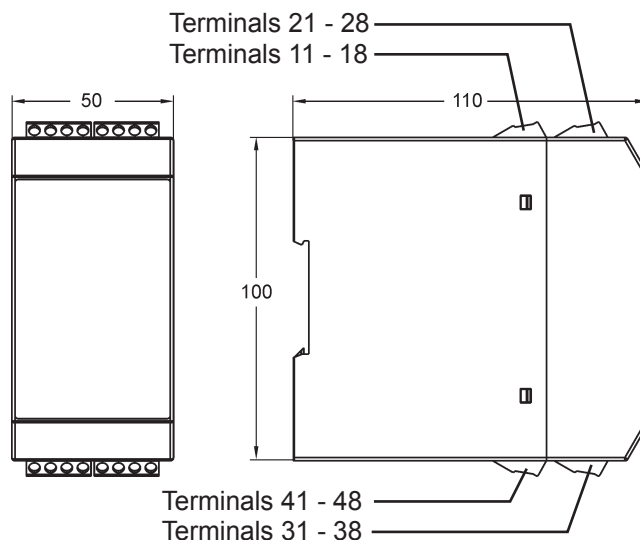



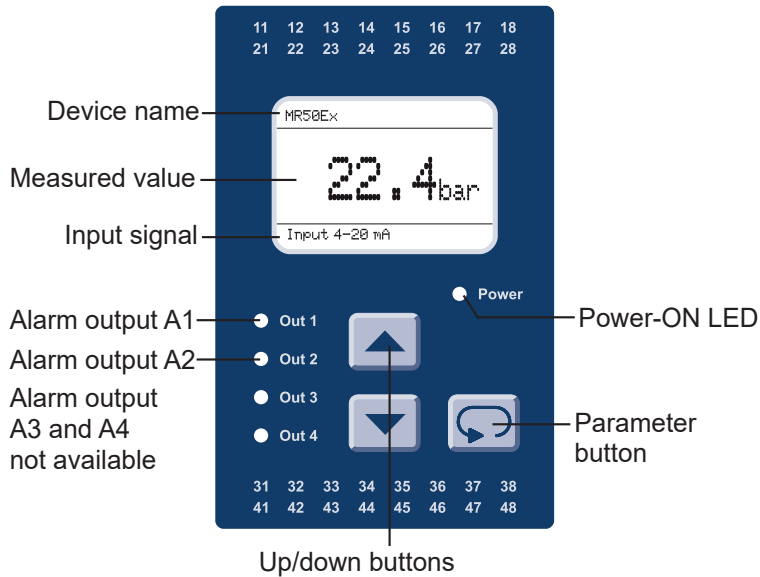

Control and indicators

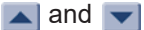



Description

The operation of the device is implemented in 2 levels. The required parameter is called up with the button . The selection within a parameter and the setting-adjustment of a value is implemented with the buttons .

Button combinations (press buttons simultaneously):

-  +  1 Parameter back
-  +  Parameter is set to "0" or minimum value.

After the switching on the supply voltage, the device initializes itself. In the display the message indicating the device type and software version is shown. After the initialization, the device is running in the working level. The peak value storage is called up and the setpoints of the alarm outputs can be programmed.

The configuration level is called up by activation of the button  for 2 seconds. In this case, all parameters which determine the properties of the device are programmed. After the last menu item, or if no button is pressed for longer than 2 minutes, a skip-back into the working level is implemented automatically and the current measured value is indicated in the display. The configuration level can be exited at any time by holding down button  for 2 seconds.

Error reports

In case of occurring faults, the messages are shown on the display in plain text. This simplifies location of the error. See explanations page 11.

Operational startup reference!

The device is preset with an ex-works default setting. Therefore it must be adapted to each special application. See page 6.

Requirements

- It is necessary to keep the conditions of the ATEX EC-Type Examination Certificate.
- The device must be installed in dry and good monitored rooms.
- If the intrinsic safety input is connected to the dust and dangerous area of zone 20 or 21, it has to be ensured that the corresponding devices in this circuit have the requirements of category 1D or 2D.
- Repairing and design modifications are only allowed at works.

Note on the representation



Parameter appears only with corresponding configuration



Parameter appears only with corresponding equipment version

Working level

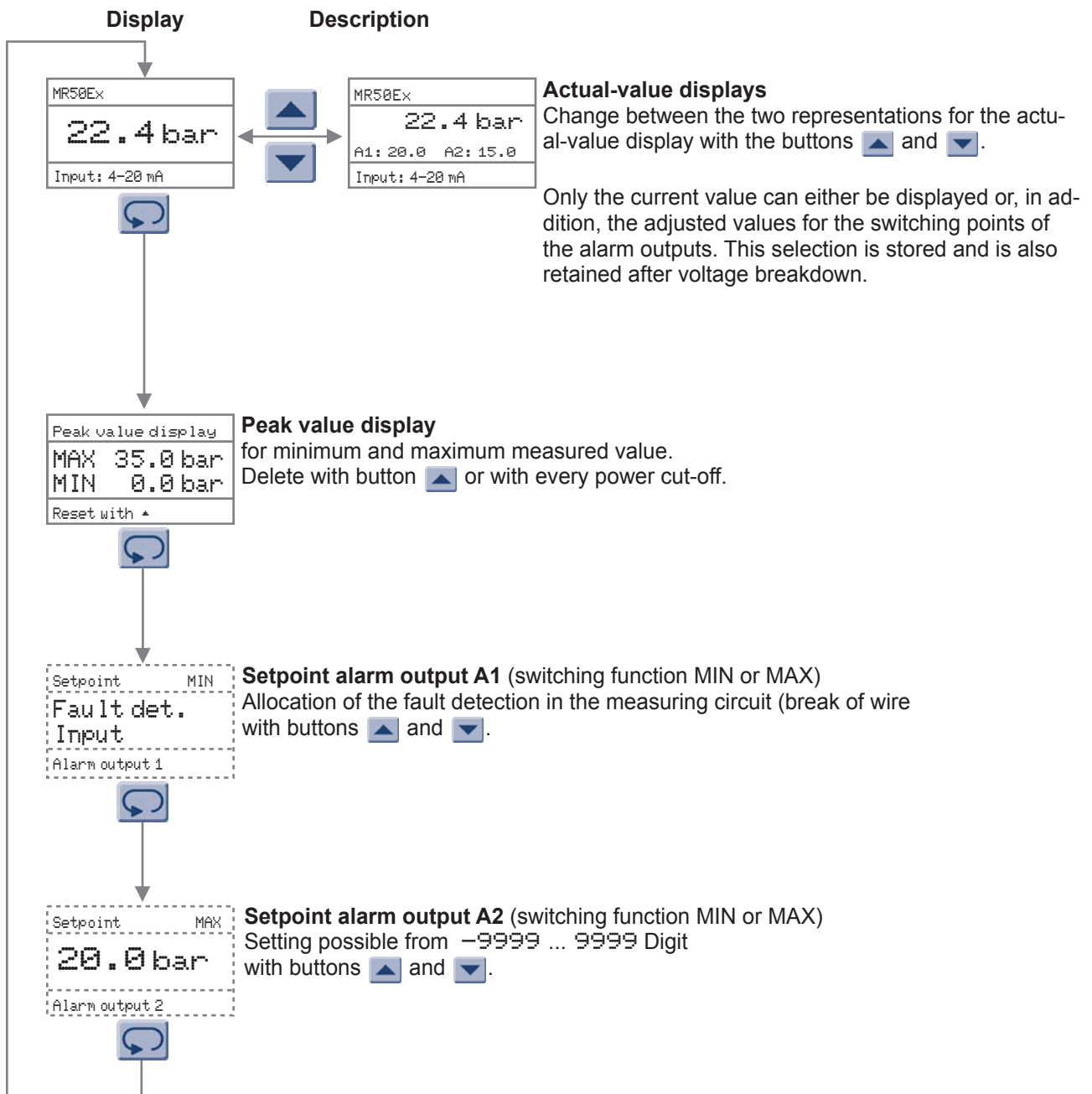

Configuration level

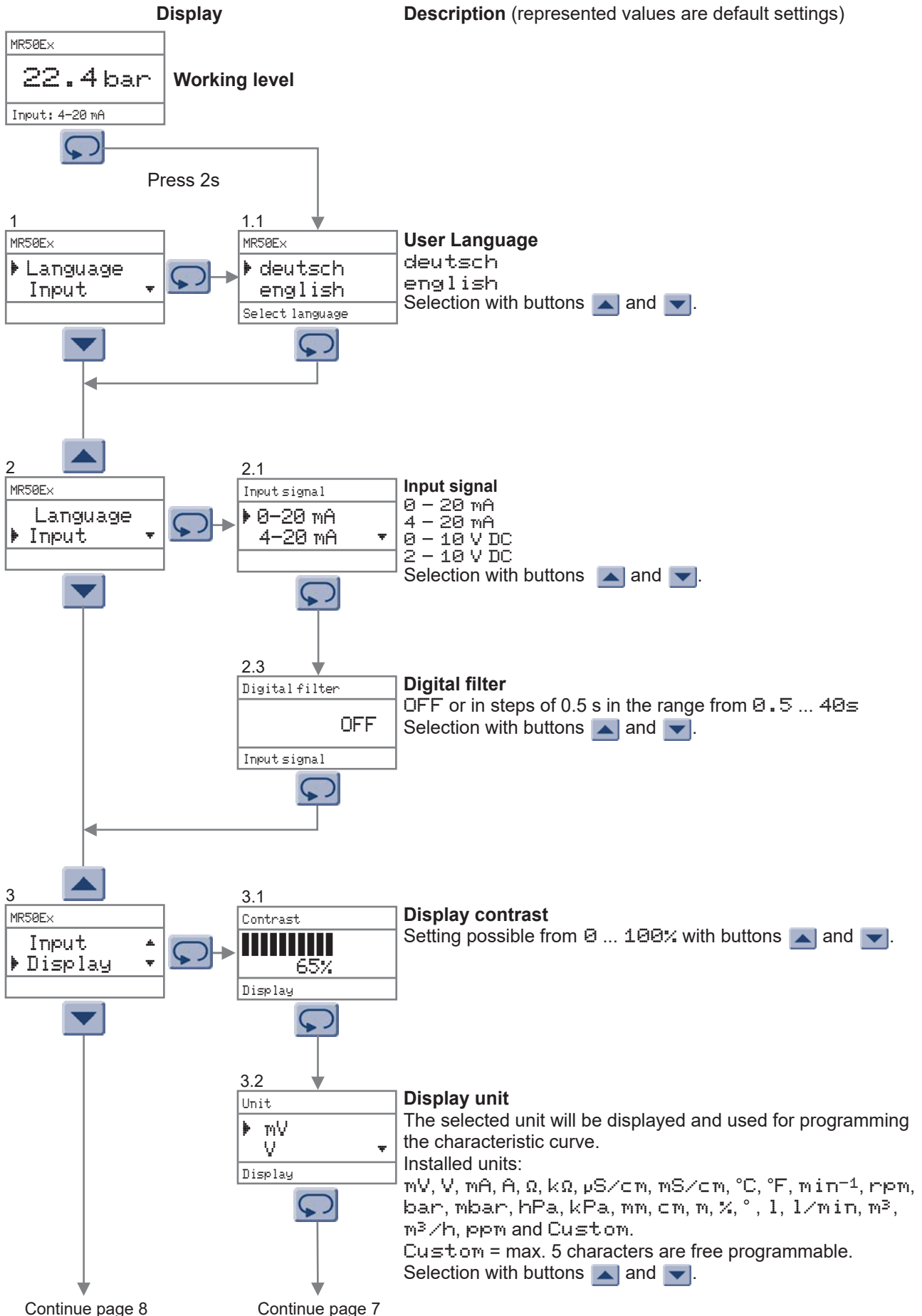

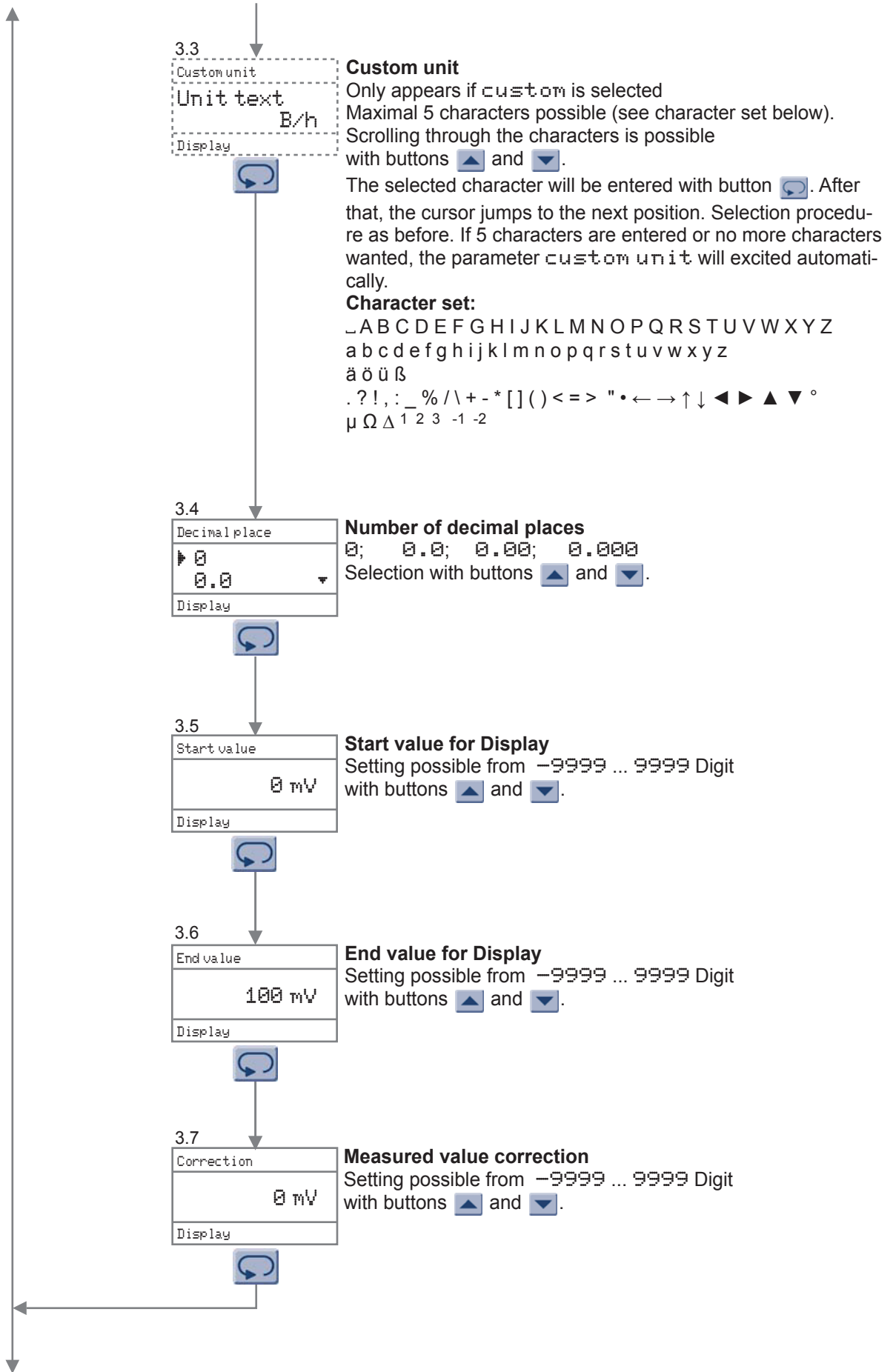

Continue page 8

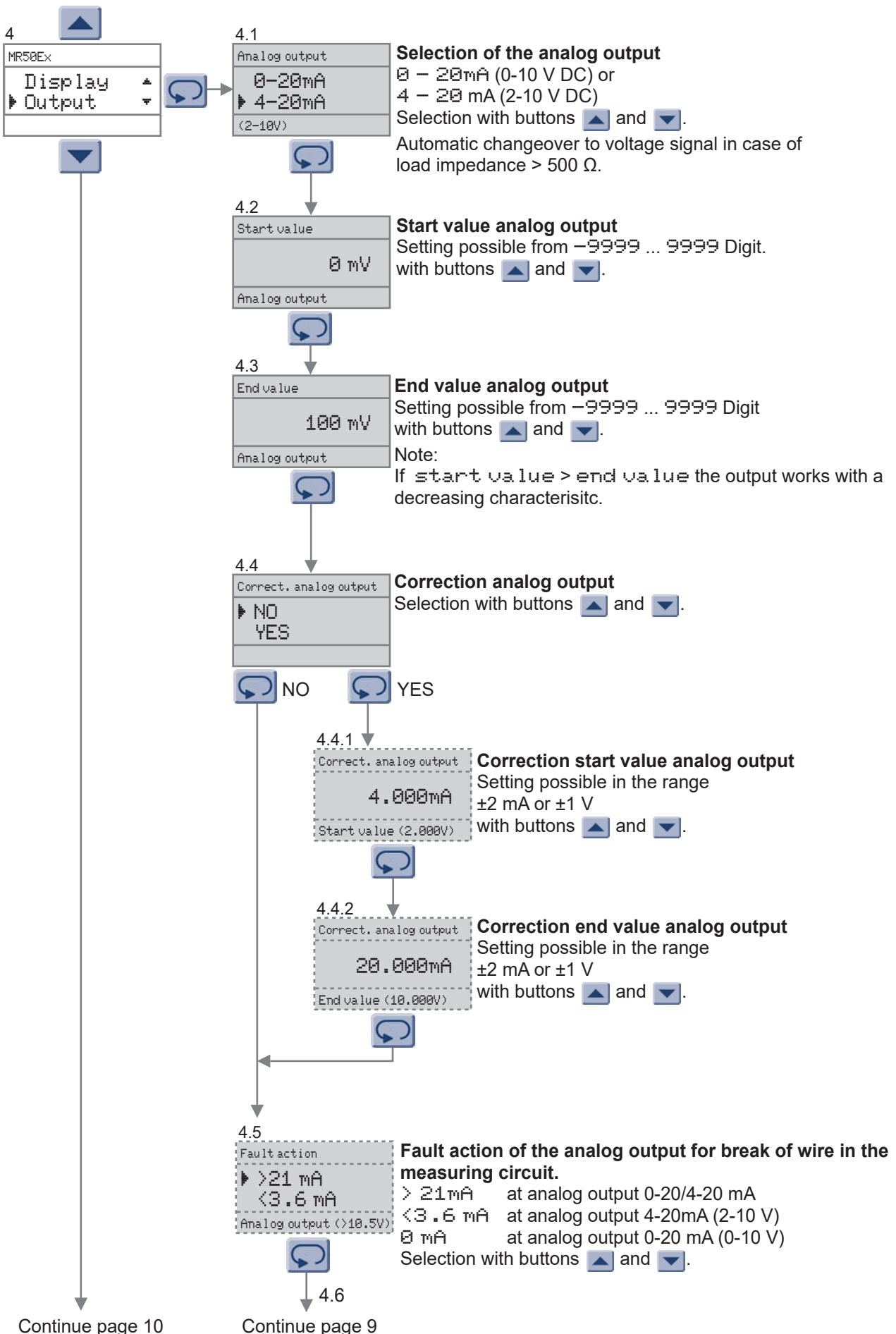

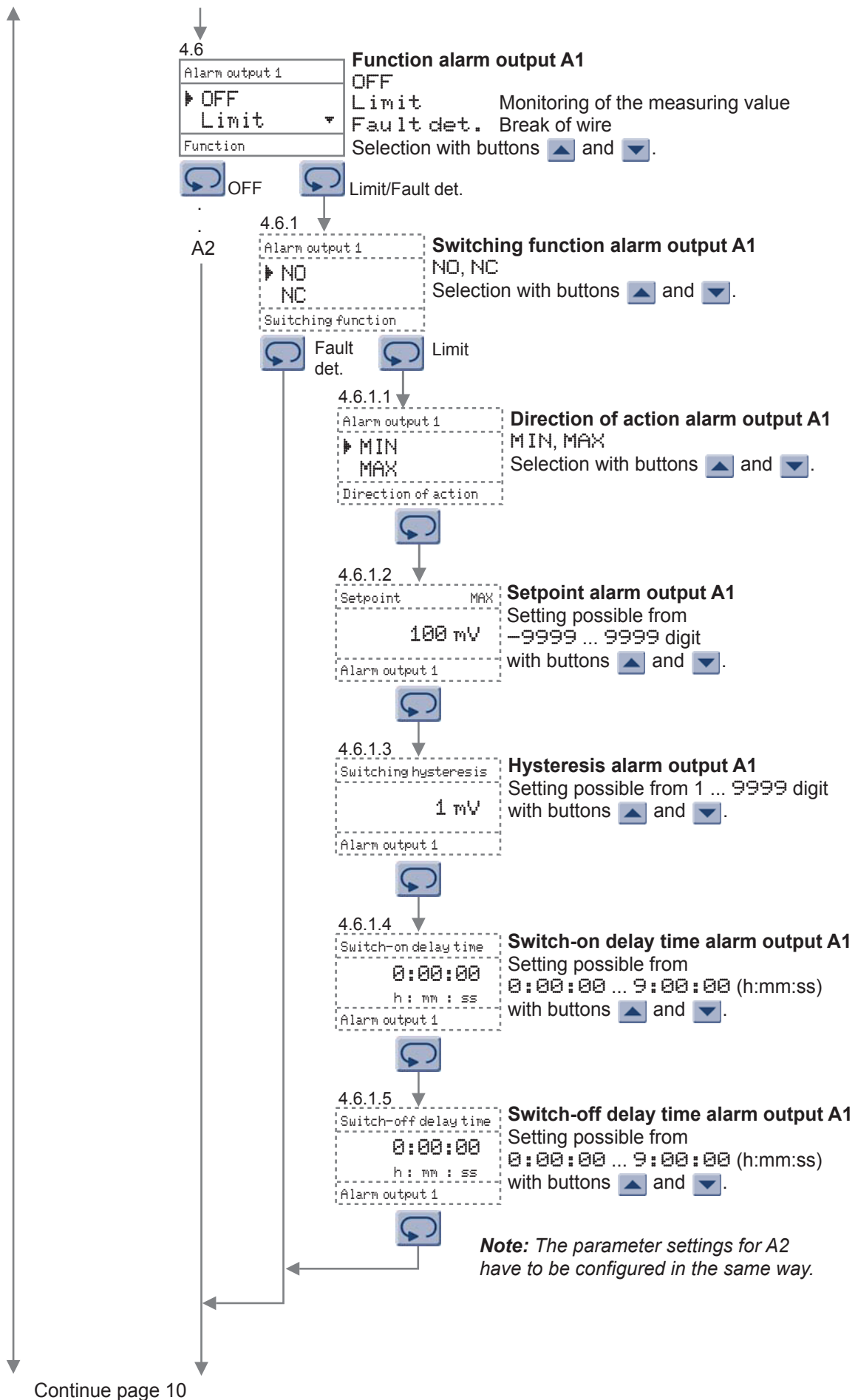

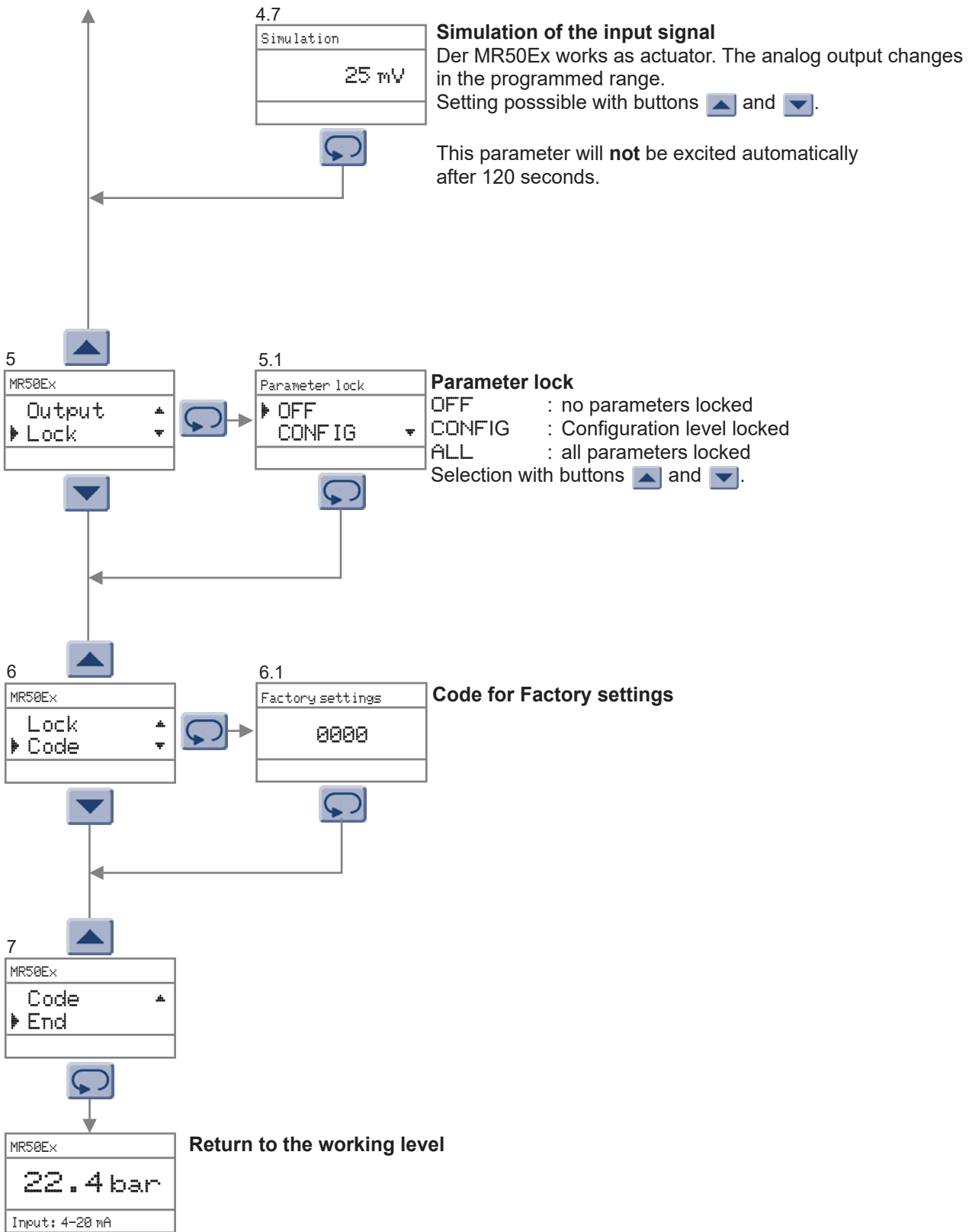

Error reports

Description

Caution!
Parameter locked
switched on

The parameter can not be changed, because the parameter lock for the configuration level, or work and configuration level, is switched on.

Caution!
Undervoltage

Supply voltage to low

Caution!
XX Parameter error
Please check

At the check-up of the parameter memory, XX errors are detected. The incorrect parameters are reset to the factory settings. Please check and correct parameters if necessary.

Caution!
XX Parameter error
Calibration necessary

As before, but the factory settings are incorrect. The device must be checked at work.

Change of decimals?
Some parameters not representable! Adapt parameters automatically?
▲ Yes ▼ No

Change of decimal places

While changing number of decimal places, some parameters can be converted, but however, not represented!

Selection "No" : Change of the decimal places is not carried out.

Selection "Yes" : Decimal places are changed automatically, where the affected parameters are set to the maximum possible value. A subsequent verification of the accepted parameters is absolutely necessary.

MR50Ex
Fault input
Input: 9999mV

Break of wire in the measuring circuit.
Text Input: 9999mV is flashing.

Ordering code

MR50Ex - 1. - 2. - 3. - 4. - 5. - 6.

1. Input

1 Standard signals 0/4 ... 20 mA; 0/2 ... 10 V DC
Transmitter supply 16 DC V max. 20 mA
Input intrinsic safety ATEX II (1) G [Ex ia] IIC/IIB
ATEX II (1) D [Ex iaD]

2. Alarm outputs

2R 2 Relay outputs A1, A2 SPDT

3. Alarm outputs

00 not installed (not available)

4. Analog output

00 not installed
AO Analog output 0/4 ... 20 mA; 0/2 ... 10 V DC

5. Supply voltage

0 230 V AC ± 10 % 50-60 Hz
1 115 V AC ± 10 % 50-60 Hz
5 24 V DC ± 15 %

6. Options

00 without option

Works configuration according to customer specifications.