

## Flow transmitter LABO-HR2E-I / U / F / C



- Optimised for use with water
- 4..20 mA output linearised
- 0..10V output linearised
- Frequency output proportional, linear
- Programmable through teaching
- LED for status display
- All metal housing
- Fully potted IP 67
- All parameters programmable via USB interface ECI-1

### Characteristics

Mechanical flow switch, for fluid media, with spring-supported piston and magnetic triggering of Hall sensors. Robust construction in brass or stainless steel.

The LABO electronics make various output signals available:

- Analog signal 0/4...20 mA (LABO-HR2E-...I)
- Analog signal 0/2..10 V (LABO-HR2E-...U)
- Frequency signal (LABO-HR2E-...F) or
- A value signal Pulse / x Litres (LABO-HR2E-...C)

A model with switching output is also available.

If desired, the range end value can be set to the currently existing flow using "teaching".

### Technical data

<b>Sensor</b>	analog Hall sensors	
<b>Nominal width</b>	DN 32 / 40 / 50	
<b>Process connection</b>	female thread G 1 <sup>1</sup> / <sub>4</sub> ..G 2 (further process connections available on request)	
<b>Metering range</b>	5..300 l/min	For details see table "Ranges"
<b>Pressure loss</b>	~ 1 bar at Q <sub>max</sub>	
<b>Q<sub>max</sub></b>	up to 300 l/min	
<b>Measurement accuracy</b>	±8 % of full scale value	
<b>Pressure resistance</b>	PS 200 bar	
<b>Medium temperature</b>	-20..+85 °C, optionally -20..+120 °C	
<b>Ambient temperature</b>	-20..+70 °C	
<b>Media</b>	water	
<b>Wiring</b>	see section "Wiring"	
<b>Materials medium-contact</b>	<i>Brass construction:</i> CW614N nickelled, CW614N, 1.4305, 1.4310, hard ferrite	<i>Stainless steel construction:</i> 1.4571, 1.4310, hard ferrite
<b>Non-medium-contact materials</b>	CW614N nickelled	
<b>Power supply</b>	18..30 V DC	
<b>Power consumption</b>	< 1 W	
<b>Outputs</b>	<p>LABO-....I: Current output 4..20 mA (alternatively 0..20 mA) Max. load 500 Ohm</p> <p>LABO-....U: Voltage output 0..10 V (alternatively 2..10 V) Load min. 1 kOhm</p> <p>LABO-....F: Frequency output Transistor output "Push-Pull" (resistant to short circuits, and reversed polarity protected) I<sub>out</sub> = 100 mA max. Selectable frequency, max. 2 kHz</p> <p>LABO-....C: Transistor output "Push-Pull" I<sub>out</sub> = 100 mA max. Pulse width 50 ms Pulse/Value is to be specified when ordering</p>	
<b>Electrical connection</b>	for round plug connector M12x1, 4-pole	
<b>Display</b>	yellow LED (On = Normal / Off = Alarm / rapid flashing = Programming)	
<b>Ingress protection</b>	IP 67	
<b>Weight</b>	see table "Dimensions and weights"	
<b>Conformity</b>	CE	
<b>Installation location</b>	Standard: horizontal inwards flow; other installation positions are possible; the installation position affects the metering and switching range.	

### Signal output curves

Value x = Begin of the specified range

 = not specified range

Current output

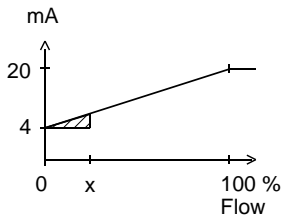

Voltage output

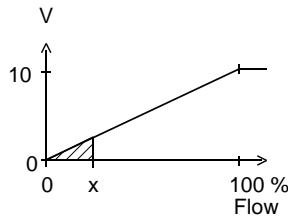

Frequency output

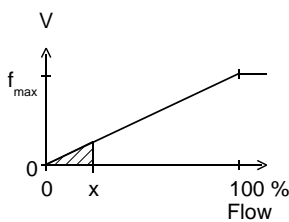

$f_{max}$  selectable in the range of up to 2000 Hz

Other characters on request.

### Ranges

Details in the table correspond to metering ranges with horizontal inwards flow and increasing flow rate.

#### Standard type LABO-HR2E

Metering range l/min H <sub>2</sub> O	Q <sub>max.</sub> recommended
5 - 60	300 l/min
10 -100	300 l/min
15 -200	300 l/min
25 -300	300 l/min

Special ranges are available.

### Wiring

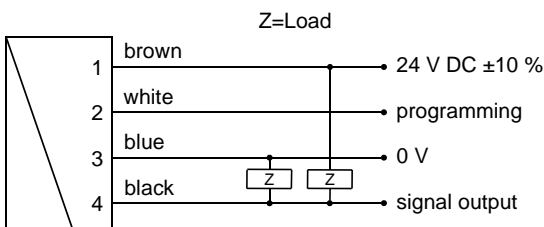

Connection example: PNP NPN

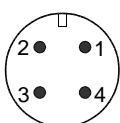

Before the electrical installation, it must be ensured that the supply voltage corresponds to the data sheet.

It is recommended to use shielded wiring.

The Push-Pull output can as desired be switched as a PNP or an NPN output.

### Dimensions and weights

..including LABO electronics

DN	G	Types	L	ØD	SW	Ød	X	Weight kg
32	G 1¼	HR2E -032GM	130	65	60	51	23	2.6
40	G 1½	HR2E -040GM	170	65	60	56	24	3.2
50	G 2	HR2E -050GM	185	80	75	70	26	5.3

High temperature

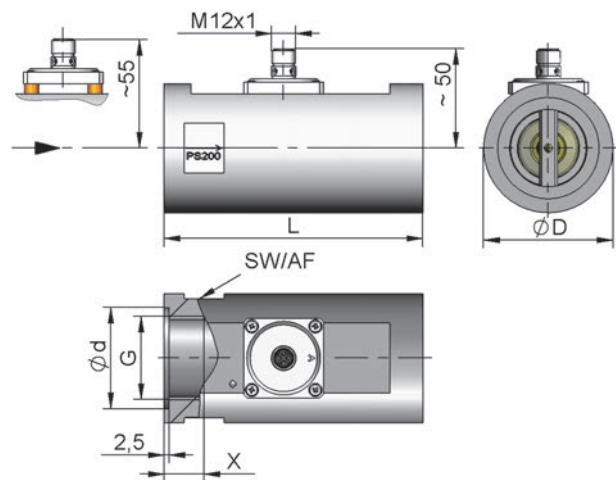

### Handling and operation

#### Note

The metering range end value can be programmed by the user via "teaching". Requirement for programmability must be stated when ordering, otherwise the device cannot be programmed.

The ECI-1 device configurator with associated software is available as a convenient option for programming all parameters by PC, and for adjustment.

The teaching option is not available for LABO-HR2E-C.

- Include straight calming section of 5 x DN in inlet and outlet.
- Include a filter if the media are dirty (use magnetic filter for ferritic components)

### Operation and programming

The teaching process can be carried out by the user as follows:

- The flow rate to be set is applied to the device.
- Apply an impulse of at least 0.5 seconds and max. 2 seconds duration to pin 2 (e.g. via a bridge to the supply voltage or a pulse from the PLC), in order to accept the measured value.
- When teaching has been successfully completed, pin 2 should be connected to 0 V, so as to prevent unintended programming.

The devices have a yellow LED which flashes during the pro-

gramming pulse. During operation, the LED serves as a display for operating voltage (for analog output) or of switching status (for frequency or pulse output).

To avoid the need to transit to an undesired operating status for the purpose of teaching, the device can be provided ex-works with a teach-offset. The teach-offset point is added to the currently measured value before saving. The offset point can be positive or negative.

*Example: The end of the metering range should be set to 80 %. However, only 60 % can be achieved without problem. In this case, the device would be ordered with a "teach-offset" of +20%.. At a flow rate of 60 % in the process, teaching would then store a value of 80 %.*

There are many more parameters which can be programmed by the ECI-1 device configurator if necessary.

## Ordering code

The basic device is ordered e.g. HR2E-032GM100 with electronics e.g. LABO-HR2E-CPSPD

HR2E -  1.  2. **G**  3.  4.

LABO - HR2E -  5.  6.  7. **S**  8. **D**

○=Option

<b>1. Nominal width</b>		
032		DN 32 - G 1¼
040		DN 40 - G 1½
050		DN 50 - G 2
<b>2. Process connection</b>		
G		female thread
<b>3. Connection material</b>		
M		brass
K		stainless steel
<b>4. HR2E - Metering range H<sub>2</sub>O for horizontal inwards flow</b>		
060		5 - 60 l/min
100		10 - 100 l/min
200		15 - 200 l/min
300		25 - 300 l/min

<b>5. Signal output</b>		
I		current output 4..20 mA
U		voltage output 0..10 V
F		frequency output
C		pulse output
<b>6. Programming</b>		
N		cannot be programmed (no teaching)
P	<input type="radio"/>	full scale value can be programmed (teaching possible)
<b>7. Electrical connection</b>		
S		for round plug connector M12x1, 4-pole
<b>8. Optional</b>		
D	<input type="radio"/>	medium temperature up to 120 °C (with spacers)

## Required ordering information

For LABO-HR2E-...F:

Output frequency at full scale  Hz  
Maximum value: 2000 Hz

For LABO-HR2E-...C:

The volume must be specified for the pulse output version (with numerical value and unit) which will correspond to one pulse.

Volume per pulse (numerical value)

Volume per pulse (unit)

## LABO options

Special range for analog output:  l/min

<= Metering range  
(Standard=Metering range)

Special range for frequency output:  l/min

<= Metering range  
(Standard=Metering range)

Power-On delay period (0..99 s)  s

(time after applying power during which the outputs are not activated or set to defined values)

Teach-offset  %

(in percent of the metering range)  
Standard = 0 %

## HR2E options

- Special values

Further options available on request.

## Accessories

- Cable/round plug connector (KB...) see additional information "Accessories"
- Converter OMNI-TA
- Device configurator ECI-1