

HD 32MT.1 METEO DATA LOGGER

The **HD32MT.1** is a data logger capable of capturing and logging the values measured by a series of sensors connected to its inputs.

The data logger is completely programmable by the user and is therefore very versatile. The supplied **HD32MTLogger** application software, supplied with the instrument, allows simple and intuitive programming by using graphic interfaces, without the need of learning any programming language, thus minimizing the time needed to make the system operational.

The values recorded by the instrument can be transferred to a PC by using the **HD32MTLogger** software. The data logger can be configured to memorize the instant value, the minimum value, the maximum value, the average value and the standard deviation of the measurements. For measurements that require the counting of pulses, the total counted pulses can be stored.

Different acquisition/recording intervals can be programmed per each input. Each recording includes acquisition date and time

The data logger has a "flash" internal memory arranged in circular mode: when the memory is full the new data overwrite the older ones. The number of storable measurements depends on the number of sensors employed, on the type of measurement to be stored and on the fact that the sensors are acquired all at the same time or at different instants. For example, with 8 sensors captured at the same time, 100,000 records can be stored, each one composed of 8 instantaneous measurements.

Data can also be directly recorded to a removable **SD**-type memory card with a capacity of **4 GB**. The use of a memory card allows extending the memory capacity of the instrument, allowing not to loose the data when the memory is full.

Three data logger versions are available, according to the possibility of communication with the PC:

- **Basic version:** the communication with the PC for data transfer or programming is done via cable connection.
- **Version with Radio Modem option:** in addition to the direct cable connection to your PC, you can transfer the data and program by **VHF** radio using optional external radio modems.
- **Version with TCP/IP option:** data transfer and programming can be done via TCP/IP via optional external **Ethernet** Serial Server.

All versions can be equipped with an optional **GSM** module to be connected externally to the instrument, through which you can send alarm **SMS** to mobile phones and send the recorded data by **e-mail** or to an **FTP** address.

The instrument can be connected to the most common sensors used in industrial and environmental fields, with both analog and digital output.

The typical sensors that can be connected to the instrument are:

- sensors with analog voltage output, both unipolar and bipolar;

- sensors with analog current output (0...20mA, 4...20mA);
- type K, J, T, N, R, S, B, E thermocouple temperature sensors; with automatic cold junction compensation by using a temperature sensor internal to the data logger;
- Pt100/Pt1000 and NTC temperature sensors;
- Sensors with digital output (TTL levels), or analog (periodical), for counting measures, frequency and period (e.g. sensors for soil water content)
- Resistors and potentiometers to measure resistance and voltage relationship (e.g. vane anemometer)
- magnetic sensors with reed contact (e.g. open door)
- solar radiation sensors (pyranometers, albedometers, net-radiometers, luxmeters, pyrgeometers, duration of irradiation)
- sensors with open/close contact output (e.g. rain gauges, cup anemometers);
- sensors with RS485 output and MODBUS-RTU protocol;
- HD2003 and HD52.3D series Delta Ohm anemometers.

Calculated quantities:

- Dew Point, Heat Index, Wind Chill, Saturation Vapour Pressure
- Custom mathematical formulas applied to the measured quantities, with arithmetic operators, logical, mathematical and trigonometric functions, control functions (IF... THEN)
- Reference Evapotranspiration **E_{to}** with FAO Penman-Monteith method.

There are potential-free contact alarm outputs and digital alarm outputs. The outputs are activated if the values measured by sensors connected to data loggers exceed the programmed thresholds. The data logger is able to store and report error conditions caused by malfunction of the connected sensors, hardware or data logger during acquisition and storage. The alarm outputs can also be programmed to detect such errors.

The instrument is particularly suitable for use in weather stations, for the detection and remote transmission of climatic variables. Delta Ohm manufactures a wide range of sensors for measuring environmental variables that can be connected to the data logger, including sensors for measuring temperature, humidity, barometric pressure, wind speed, solar radiation, amount of rainfall, etc.

The data logger can be supplied with a program of measures and stores pre-installed according to specifications of the customer, in order to be operational immediately after installation of the system. The program is installed directly from Delta Ohm to meet the required specifications when ordering. Some features of the data logger are **password** protected (Clock Setup, User Code Setup, Send Program, GSM Setup). If needed the password is entered by the user at the time of connection.

Power supply from 12 to 30 Vdc. The system can also be powered by a solar panel and backup battery of adequate capacity, allowing for installation in remote sites without electrical power. An internal lithium battery keeps the date and time of the instrument in the absence of external power. The data logger can provide power to all sensors connected at its terminals. It can signal and store when the supply voltage is below a programmable threshold and go into wait (standby) mode to low power consumption. In this mode, the datalogger interrupts the power supply to all sensors and suspends acquisitions/loggings, until the supply voltage returns at least to the minimum threshold.

Technical characteristics

Sizes / Weight	222x140x63 mm / About 1 kg
Case material	Coated aluminium
Operating conditions	-20 ... 50 °C, 0 ... 85% RH no condensation
Storage temperature / Power Supply	-25 ... 65 °C / 12 ... 30 Vdc
Absorption	40 mA @ 12 Vdc
Data acquisition interval / Data logging interval	Programmable from 1 to 60 seconds / Programmable from 2 seconds to 24 hours
Storage capacity	4 MB internal memory SD memory card reader up to 4 GB
Number of samples that can be stored	The storage of a record consisting of N values requires (4 x N) bytes of memory plus 8 bytes for the date and time.
Analog inputs	16 channels, each channel used as a single-wire (single-ended) input or alternatively two adjacent channels used as a differential input. Measurement ranges: ±25 mV, ±100 mV, ±1000 mV, ±2500 mV Resolution: 16 bit, Accuracy: 0.01% f.s. Input impedance: 100 Mohm
Digital input/output ports (I/O)	8 ports, each configurable as an input for connecting a sensor or alarm output or sensor enabling. TTL logic levels (0⇒Vin<0.8 V, 1⇒Vin>3 V) Max. input voltage: 5.5 V
Inputs for high frequency pulse counting	2 inputs Frequency of pulses 100 kHz max. TTL logic levels (0⇒Vin<0.8 V, 1⇒Vin>3 V) Minimum pulse duration 10 µs
Inputs for number of potential-free contact opening/closing counting	2 insulated inputs Switch frequency 50 Hz max. Minimum opening or closing time 10 ms
RS485 connection	RS485 port (up to 8 sensors can be connected) for Anemometers series HD2003 and HD52.3D and sensors with MODBUS-RTU protocol.
RS232 connection	2 RS232 ports, one for connection to PC or to optional Radio Modem or to optional Ethernet module and one for connection to optional GSM module. Sub-D 9-pole male connectors
Alarm outputs	2 insulated voltage-free contact outputs Contact: max. 1 A @ 30 Vdc resistive load You can configure the single digital I/O ports as alarm outputs
Auxiliary supply outputs	+5V regulated, max. 500 mA +Vsw (switched): with same value of the power input, it is active only during acquisition of measurements

Description of terminals

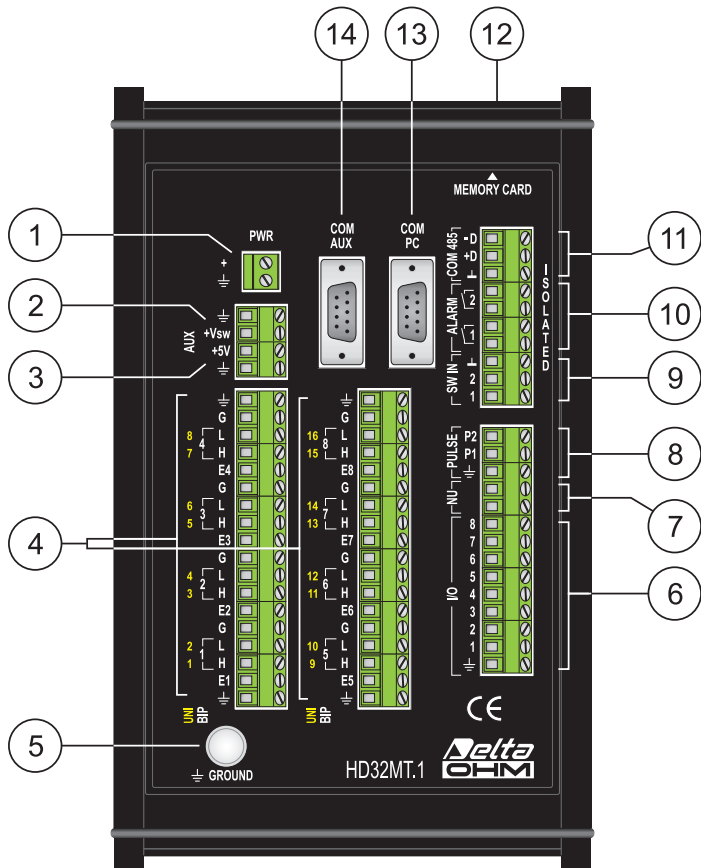

Display

It is possible to connect an **optional** LCD display to the data logger, to check the values acquired by the data logger without having to connect your PC. The display is available in the basic version (**HD32.D**), or with the GPS option (**HD32.D.GPS**) to automatically update the clock of the data logger. The displays are designed for being fixed to the outdoor housings HD32.35, HD32.35FP, HD32.36 and HD32.36FP. The display is backlit and connects to the data logger **COM PC** RS232 serial port. The supply voltage required by the display is 8...30 Vdc.

1. Power input **PWR** 12...30 Vdc.
2. Switched power supply output **+Vsw**. With the same value of the power input, but **active only during acquisition of measurements**.
3. Regulated power supply output **+5V**.
4. Inputs for analogue signals. Divided into 8 channels corresponding to 8 differential inputs (**BIP** channels) or 16 single-ended inputs (**UNI** channels). The differential input number is shown in white to the left of the terminals.
Each channel is composed of four terminals:
Terminal **E**: Excitation voltage. Used only in certain measurement configurations.
Terminal **H**: If the channel is used as a differential input, it corresponds to the "+" connection of the input signal. If the channel is used for single-ended inputs, it corresponds to the "+" connection of the input signal of the single-ended channel with the number indicated in yellow to the left of the terminal.
Terminal **L**: If the channel is used as a differential input, it corresponds to the "-" connection of the input signal. If the channel is used for single-ended inputs, it corresponds to the "+" connection of the input signal of the single-ended channel with the number indicated in yellow to the left of the terminal.
Terminal **G**: Analog ground. It has the same potential of the power supply ground. If the channel is used for single-ended inputs, it corresponds to the "-" connection of the input signal.
5. Terminal for ground protection.
6. Digital input/output channels. 8 channels are available, each one usable as input for connection of sensors with ON/OFF digital output, or as alarm outputs.
7. Not used.
8. **PULSE** inputs for high frequency pulse counting Two inputs are available, marked with P1 and P2.
9. Insulated inputs **SW IN** for number of voltage-free contacts opening/closing count. Two inputs are available, marked with 1 and 2.
10. Voltage-free contact alarm outputs. Two outputs are available, marked with 1 and 2.
11. RS485 serial port for the connection of anemometers series HD2003 and HD52.3D..., and sensors with MODBUS-RTU protocol.
The connection to the RS485 port of sensors other than those indicated may not work properly due to a different communication protocol.
12. Memory card reader.
13. RS232 serial port **COM PC**, for direct connection to the PC or for connection of the **optional** Radio Modem (Radio Modem version) or of the optional Ethernet module.
14. RS232 serial port **COM AUX** for connection of the **optional** GSM module.

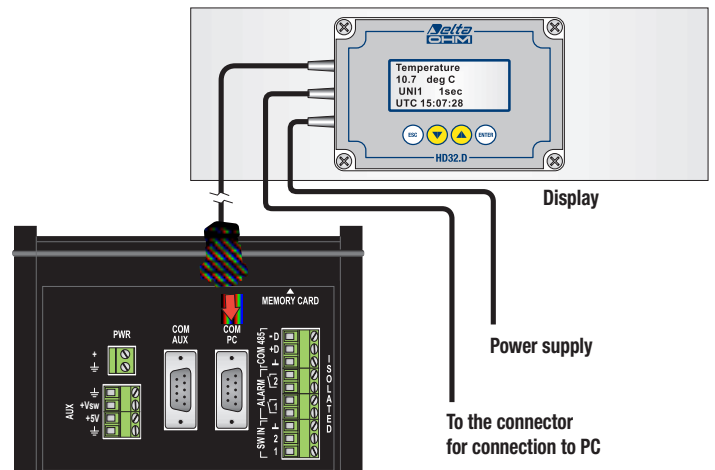

Connection of the display

For each measurement is displayed: the name of the parameter measured, the value of the measure, the unit of measurement, the data logger input the sensor is connected to, the acquisition interval and the current UTC time in the data logger. The various measures are automatically scrolled on the display, or alternatively can be scrolled manually.

Data communication

There are different ways to communicate the stored data to the PC:
direct cable communication;
• communication via VHF radio modem (radio modem version only);
• communication via a Local Area Network (LAN) with TCP/IP protocol (an optional RS232/Ethernet module is required);
• communication via the GSM network (only if the optional GSM module is present).
The communications via VHF Radio Modem and GSM module are especially useful for installations in remote unattended areas
Via the GSM connection, the data logger is capable of sending alarm messages via **SMS** to mobile phones, and stored data via Internet to **e-mail** and **FTP** addresses. In the GSM module must be inserted a **SIM** card enabled for data transmission, to be obtained from a telephone operator that has a suitable GSM network coverage in the place where the system will be installed.

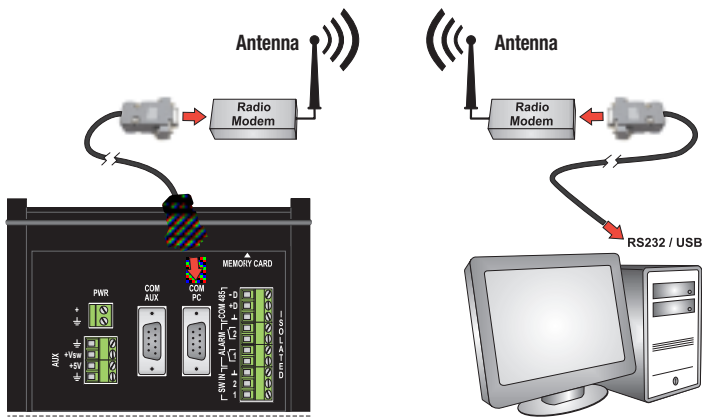

Communication via VHF Radio Modem

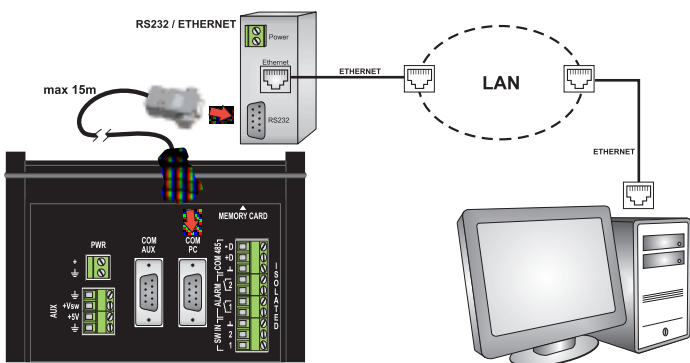

Communication via local area network with TCP/IP protocol

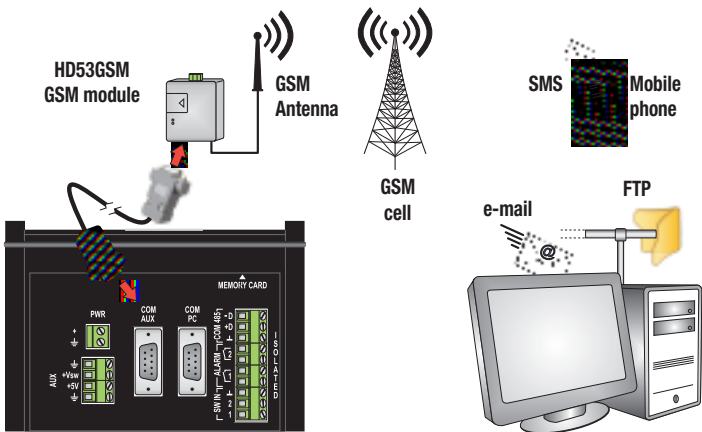

Communication via GSM network

Connection of sensors

The data logger is designed for the connection of a wide variety of sensors, with both analog and digital output, used in many application fields. Only to show a few examples, the connections of some devices of widespread use are illustrated.

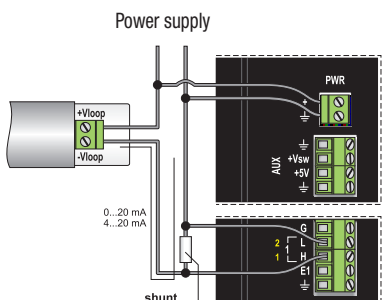

2-wire current output transmitters

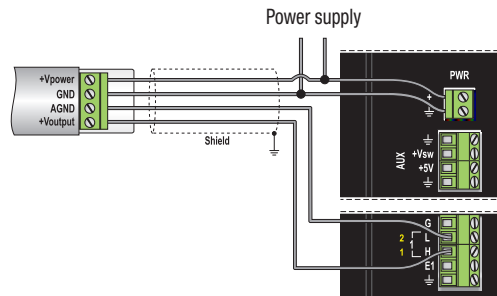

Voltage output transmitters

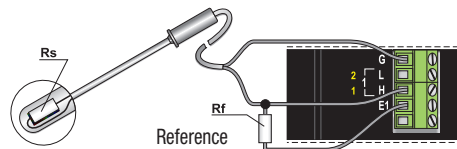

2-WIRE RESISTIVE SENSORS

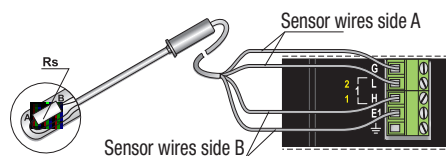

4-wire resistive sensors (Pt100/Pt1000)

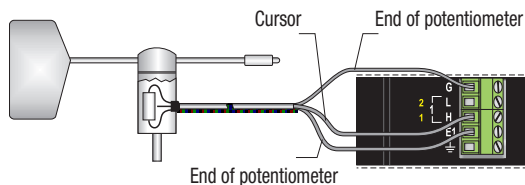

3-wire potentiometric sensors

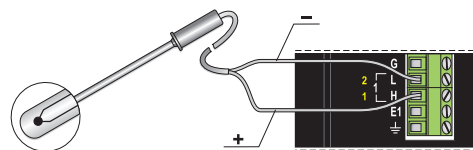

Thermocouples / sensors with mV output

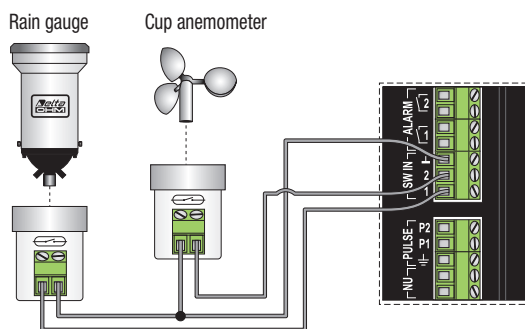

Sensors with contact frequency output

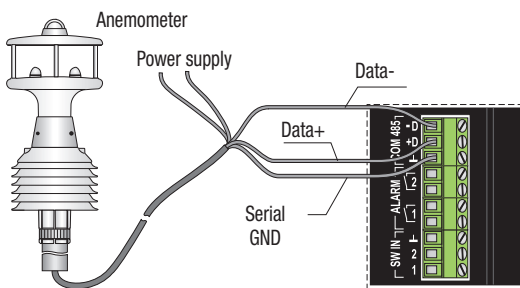

Delta OHM anemometers
Sensors with RS485 Modbus-RTU output

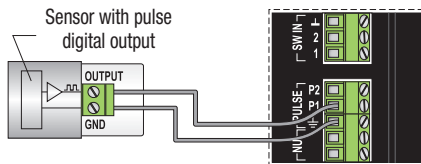

Sensors with digital frequency output

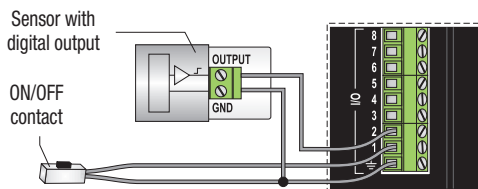

Acquisition of logic states

Dimensions

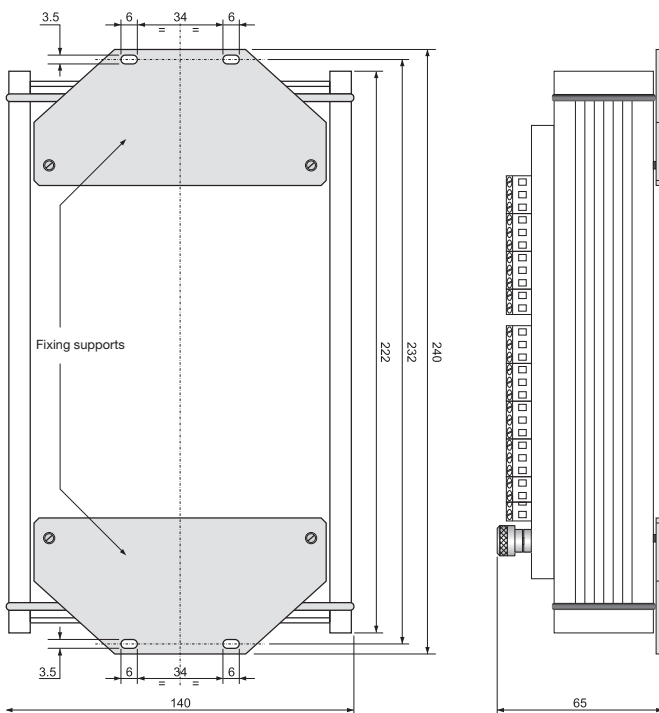

Order codes

HD32MT.1: Data logger supplied with: **HD32MTLogger** software for programming, data downloading, monitoring and data processing on a PC, operating manual.

The probes, the cables, the GSM module and the display must be ordered separately. The radio modem option should be requested at time of ordering, the radio modem modules with the antennas must be ordered separately.

Accessories

HD32MTLogger: Further copy of CD-ROM with software HD32MTLogger for programming, data download, monitor and PC data management. For Windows® operating systems.

9CPRS232: Null modem cable with 9-pin Sub-D female connector on both sides for connection to the PC RS232C. Cable length 2 m.

C.205: Connection cable with USB connector on PC side and sub-D 9-pole female connector on instrument side. The cable has a built-in RS232/USB converter and connects the data

logger directly to the USB port of the PC.

C.205M: Connection cable with USB connector on PC side and sub-D 9-pole male connector on Radio Modem side. The cable has a built-in RS232/USB converter and connects the Radio Modem directly to the USB port of the PC.

HD32.35: Outdoor housing complete with acquisition system for weather stations. **Material:** **AISI 304 stainless steel.** Screen to protect the housing from solar radiation, powder-coated anodized aluminum. White. Double locking one of which is a key. Dimensions 450 x 300 x 210 mm. Degree of protection IP66. Supplied with accessories for attachment to the pole diameter 36 ÷ 52 mm. **Provided for 100 ÷ 240Vac mains power supply**, includes: HD32MT.1 data logger, AC/DC power supply unit with integrated battery charger, 12V rechargeable backup battery, surge protectors, disconnectors, terminal block for power supply distribution and connectors for connecting the external sensors. **Wired and tested.** Available with optional alarm sensor to signal the opening of the housing door.

HD32.35FP: Outdoor housing complete with acquisition system for weather stations. **Material:** **AISI 304 stainless steel.** Screen to protect the housing from solar radiation. Powder-coated anodized aluminium white. Double locking one of which is a key. Dimensions 450 x 300 x 210 mm. Degree of protection IP66. Supplied with accessories for attachment to the pole diameter 36 ÷ 52 mm. **Provided for power supply from solar panel**, includes: HD32MT.1 data logger, solar charge controller, terminal block for power supply distribution and connectors for connecting the external sensors. **Wired and tested.** Available with optional alarm sensor to signal the opening of the housing door.

HD32.36: Outdoor housing complete with acquisition system for weather stations. **Material:** **Polyester with fiberglass-reinforced hot-moulding.** Screen to protect the housing from solar radiation, powder-coated anodized aluminum. White. Key lock. Dimensions 415 x 310 x 170 mm. Degree of protection IP66. Supplied with accessories for attachment to the stainless steel pole diameter 36 ÷ 52 mm. **Provided for 100 ÷ 240Vac mains power supply**, includes: HD32MT.1 data logger, AC/DC power supply unit with integrated battery charger, 12V rechargeable backup battery, surge protectors, disconnectors, terminal block for power supply distribution and connectors for connecting the external sensors. **Wired and tested.** Available with optional alarm sensor to signal the opening of the housing door.

HD32.36FP: Outdoor housing complete with acquisition system for weather stations. **Material:** **Polyester with fiberglass-reinforced hot-moulding.** Screen to protect the housing from solar radiation, powder-coated anodized aluminum. White. Key lock. Dimensions 415 x 310 x 170 mm. Degree of protection IP66. Supplied with accessories for attachment to the stainless steel pole diameter 36 ÷ 52 mm. **Provided for power supply from solar panel**, includes: HD32MT.1 data logger, solar charge controller, terminal block for power supply distribution and connectors for connecting the external sensors. **Wired and tested.** Available with optional alarm sensor to signal the opening of the housing door.

HD32.D: LCD viewer designed for being fixed on outdoor housings HD32.35, HD32.35FP, HD32.36 and HD32.36FP.

HD32.D.GPS: LCD viewer designed for being fixed on outdoor housings HD32.35, HD32.35FP, HD32.36 and HD32.36FP. With GPS module for automatical time synchronization of the data logger.

HD32MT.AL.M: Sensor that signals the opening of the housing door.

TP32MT.1P.I: 4-wire 1/3 DIN Pt100 temperature probe, Ø 4 mm, L=150 mm, pointed, 5 m cable, isolated sensor. Temperature range -40...+100 °C.

TP32MT.2.I: 4-wire 1/3 DIN Pt100 temperature probe, Ø 6 mm, L=150 mm, 5 m cable, isolated sensor. Temperature range -40...+100 °C.

TP32MT.11P: T type thermocouple temperature probe, Ø 4 mm, L=150 mm, pointed, 5 m cable, isolated. Temperature range -40...+100 °C.

TP32MT.12: T type thermocouple temperature probe, Ø 4 mm, L=300 mm, 5 m cable, isolated. Temperature range -40...+100 °C.

TP878.1SS.O: Temperature contact probe for solar panels, 4-wire Pt100. Cable 5 m. Temperature range +4...+85 °C.

HD4V8T Baro: Barometric transmitter with 0...1 Vdc output. Working range 600...1100 mbar. Power supply 10...40 Vdc. Temperature working range -30...+60 °C. Installation inside the outdoor housing HD32.35, HD32.35FP, HD32.36 and HD32.36FP.

HD53GSM: Quad-band wireless GSM/GPRS module, including whip antenna and RS232 serial port.

HDRM0169: VHF radio modem module pair, frequency 169 MHz, including whip antenna and RS232 serial port. Already configured for connection to the logger and the PC (the two modules are not interchangeable). The modules only work with the version of the data logger with radio modem option.

HD2004.20: Tripod kit for installing anemometers on a flat base. Material: anodized aluminum. Height 3 m.

HD2004.22: 1200 x 530 x 34 mm solar panel mounting kit to a Ø 40÷50 mm mast. AISI 304 stainless steel.

HD2004.30: 80W monocrystalline solar panel. Dimensions 1200 x 530 x 34 mm.