

## Operating manual

Manometers for Pitot tubes /  
thermometers

**HD2114P.0 – HD2114P.2**

**HD2134P.0 – HD2134P.2**



Companies / Brands of GHM

Members of GHM GROUP

**GREISINGER**

**HONSBERG**

**Martens**

**IMTRON**

**Delta OHM**

[www.deltaohm.com](http://www.deltaohm.com)

Keep for future reference.

## CONTENTS

<b>INTRODUCTION.....</b>	<b>3</b>
<b>KEYBOARD AND MENU DESCRIPTION .....</b>	<b>8</b>
<b>THE PROBES.....</b>	<b>14</b>
OPERATION .....	15
DIMENSIONS OF PITOT TUBES.....	16
FLOW RATE MEASUREMENT .....	16
TEMPERATURE MEASUREMENT .....	18
<b>WARNINGS AND OPERATING INSTRUCTIONS.....</b>	<b>20</b>
<b>INSTRUMENT SIGNALS AND FAULTS.....</b>	<b>21</b>
<b>LOW BATTERY WARNING AND BATTERY REPLACEMENT.....</b>	<b>23</b>
<b>INSTRUMENT STORAGE.....</b>	<b>24</b>
<b>SERIAL INTERFACE AND USB .....</b>	<b>25</b>
<b>STORING AND TRANSFERRING DATA TO A PERSONAL COMPUTER.....</b>	<b>27</b>
THE LOGGING FUNCTION - ONLY FOR HD2114P.2 AND HD2134P.2 .....	27
CLEARING THE MEMORY - ONLY FOR HD2114P.2 AND HD2134P.2 .....	27
THE PRINT FUNCTION - ONLY FOR HD2114P.2 AND HD2134P.2.....	28
<b>CONNECTION TO A PC.....</b>	<b>29</b>
CONNECTION TO THE RS232C SERIAL PORT OF THE INSTRUMENT - ONLY FOR HD2114P.2 AND HD2134P.2 .....	29
CONNECTION TO THE USB 2.0 PORT OF THE INSTRUMENT - ONLY FOR HD2114P.2 AND HD2134P.2.....	29
<b>NOTES ABOUT WORKING AND OPERATIVE SAFETY.....</b>	<b>30</b>
<b>INSTRUMENT TECHNICAL CHARACTERISTICS.....</b>	<b>31</b>
TYPE K THERMOCOUPLE PROBES .....	33
<b>ORDER CODES .....</b>	<b>34</b>

## INTRODUCTION

The **HD2114P.0** and **HD2114P.2**, **HD2134P.0** and **HD2134P.2** are portable micromanometers using Pitot or Darcy tubes and a large LCD display. They are used to perform measurements in the fields of air conditioning, heating and ventilation.

They measure the differential pressure detected by a Pitot or Darcy tube connected to the instrument inputs acquiring the wind speed and flow rate inside pipelines and vents. They also measure the temperature using a type K thermocouple sensor.

The HD2114P.2 and HD2134P.2 instruments are **dataloggers**. They memorize up to 36,000 samples which can be transferred from the instrument connected to a PC via the RS232C serial port or USB 2.0 port. The storing interval, printing, and baud rate can be configured using the menu.

The HD2114P.2 and HD2134P.2 instruments can transfer via the RS232C serial port the acquired measurements to a PC or to a portable printer in real time.

The *Max*, *Min* and *Avg* function calculates the maximum, minimum or average values. Other functions include: the relative measurement REL, the HOLD function, and the automatic turning off which can also be disabled.

**The instruments have IP66 protection degree.**

**If not otherwise specified, this manual's descriptions are intended to be applicable to all models.**

# HD2114P.0 - HD2134P.0

## Micromanometer with Pitot tube - Thermometer



## HD2114P.0 - HD2134P.0

1. Input for thermocouple K, standard miniature connector.
2. Positive input (+) into the pressure sensor. Quick coupling Ø 5mm
3. Battery symbol: displays the battery charge level.
4. Function indicators.
5. Secondary display line.
6. **HOLD/▲** key: freezes the measurement during normal operation; in the menu, increases the current value.
7. **FUNC/ENTER** key: during normal operation displays the maximum (MAX), the minimum (MIN) and the average (AVG) of current measurements; in the menu, confirms the current selection.
8. **REL/▼** key: enables the relative measurement (displays the difference between the current value and the logged value when the key is pressed); in the menu, decreases the current value.
9. **MENU** key: allows access to and exit from the menu.
10. **°C/°F-ESC** key: when the thermocouple probe is not connected, it allows manual modification of the temperature. When double pressed, changes the unit of measurement for temperature from degrees Celsius to Fahrenheit; in the menu, cancels the operation in progress without making changes.
11. **UNIT/DUCT CALC** key: during normal operation selects the unit of measurement for the main variable; when pressed together with the FUNC key, starts the duct flow rate calculation procedure.
12. **ON-OFF/AUTO-OFF** key: turns the instrument on and off; when pressed together with the HOLD key, disables the automatic turn off.
13. Peak, MAX, MIN and AVG symbols.
14. Main display line.
15. Degree of multiplication -3, 3 or 6: the apex, if present, indicates that the displayed measurement must be divided by 1000 (apex "-3"), multiplied by 1000 (apex "3") or by 1,000,000 (apex "6").
16. Line for symbols and comments.
17. Negative input (-) into the pressure sensor. Quick coupling Ø 5mm

# HD2114P.2 - HD2134P.2

## Micromanometer with Pitot tube - Thermometer



## HD2114P.2 - HD2134P.2

1. Input for thermocouple K, standard miniature connector.
2. Positive input (+) into the pressure sensor. Quick coupling Ø 5mm
3. External auxiliary power supply connector input (positive at centre).
4. Battery symbol: displays the battery charge level.
5. Function indicators.
6. Secondary display line.
7. **HOLD/▲** key: freezes the measurement during normal operation; in the menu, increases the current value.
8. **FUNC/ENTER** key: during normal operation displays the maximum (MAX), the minimum (MIN) and the average (AVG) of current measurements; in the menu, confirms the current selection.
9. **REL/▼** key: enables the relative measurement (displays the difference between the current value and the logged value when the key is pressed); in the menu, decreases the current value.
10. **SERIAL/ERASE LOG** key: starts and ends the data transfer to the serial communication port. In the menu, clears the data contained in the instrument's memory.
11. **LOG/DUMP LOG** key: during normal operation, starts and ends the saving of the data in the internal memory; in the menu, starts the data transfer from the instrument's memory to the PC.
12. Mini-USB type B connector for USB 2.0. For the connection to PC (with cable CP23).
13. **MENU** key: allows access to and exit from the menu.
14. **°C/°F-ESC** key: when the thermocouple probe is not connected, it allows manual modification of the temperature. When double pressed, changes the unit of measurement for temperature from degrees Celsius to Fahrenheit; in the menu, cancels the operation in progress without making changes.
15. **UNIT/DUCT CALC** key: during normal operation selects the unit of measurement for the main variable; when pressed together with the FUNC key, starts the duct flow rate calculation procedure.
16. **ON-OFF/AUTO-OFF** key: turns the instrument on and off; when pressed together with the HOLD key, disables the automatic turn off.
17. Peak, MAX, MIN and AVG symbols.
18. Main display line.
19. Degree of multiplication -3, 3 or 6: the apex, if present, indicates that the displayed measurement must be divided by 1000 (apex "-3"), multiplied by 1000 (apex "3") or by 1,000,000 (apex "6").
20. Line for symbols and comments.
21. 8-pole MiniDin connector for RS232C. For the connection to PC (with cable HD2110CSNM or C206) or printer (with cable HD2110CSNM).
22. Negative input (-) into the pressure sensor. Quick coupling Ø 5mm

## KEYBOARD AND MENU DESCRIPTION

### Foreword

The instrument keyboard is composed of single-function keys, like the MENU key, and double-function keys such as the ON-OFF/Auto-OFF key.

In the double-keys, the function in the upper part is the "main function", while the one in the bottom part is the "secondary function". When the instrument is in standard measurement mode, the main function is active. In the menu or in conjunction with the FUNC key, the secondary function is enabled.

The pressing of a key is accompanied by a short confirmation beep: a longer beep sounds if the wrong key is pressed.

Each key specific function is described in detail below.



### ON-OFF/AUTO-OFF key

The instrument is turned on and off using the ON/OFF key. The turning on enables all display segments for a few seconds, displays the setting of the Pitot or Darcy tube constant (please see the Cost\_PIT\_DARC parameter on page 11) and sets the instrument ready for normal measurement.

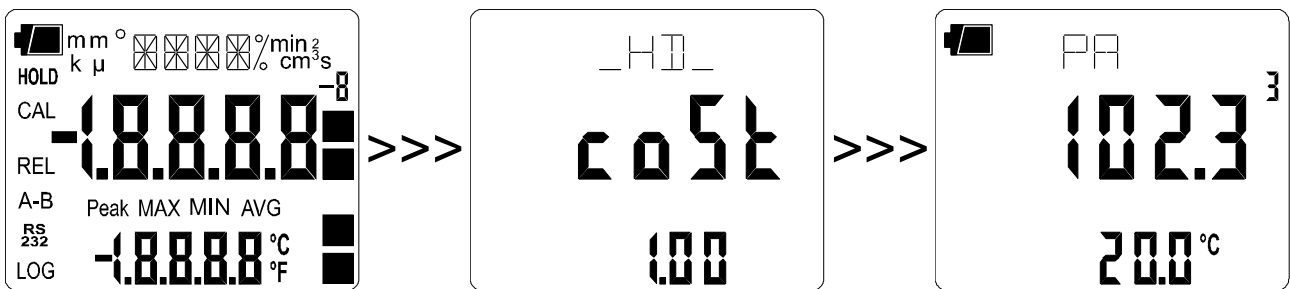

If no thermocouple probe is connected to the input, it is the manual temperature which is displayed in the secondary line. This value is 25°C by default.



+



### Automatic turning off

The instrument has an *AutoPowerOff* function that automatically turns the instrument off after about 8 minutes if no key is pressed during the intervening time. The *AutoPowerOff* function can be disabled by holding the HOLD key pressed down when turning the instrument on: the battery symbol will blink to remind the user that the instrument can only be turned off by pressing the <ON/OFF> key.

**The automatic turning off function for the HD2114P.2 and HD2134P.2 models is disabled when external power is used. On the other hand, it cannot be disabled when the batteries are discharged.**





### **FUNC/ENTER key**

During normal measurement this enables the display and logging of the maximum (MAX), minimum (MIN) and average (AVG) value of the measurements captured by the Pitot tube connected to the instrument, updating them with the acquisition of new samples. The acquisition frequency is once a second.

The calculation is performed on the pressure, wind speed or flow rate appearing on the display upon pressure of the FUNC key: by changing the unit of measurement, the Max, Min and Avg values are cleared.

The MAX, MIN and AVG measurements remain in the memory until the instrument is on, even after exiting the calculation function. To reset the previous values and restart with a new measurement session, press FUNC until the message "FUNC CLR" appears, then use the arrows to select YES and confirm using ENTER.

In the menu, the ENTER key confirms the current parameter and then goes to the next one. Pressed together with the UNIT/DuctCalc key, enables the flow rate calculation (please see the UNIT key description).

**Attention: the data captured using the Record function cannot be transferred to the PC.**



### **HOLD/▲ key**

It increases the current parameter when used in the menu; when used in measurement mode, it freezes the measurement in progress, and upon application of pressure on the key, the message **HOLD** appears in the upper side of the display. To return to the current measurement, press the key again.

Upon turning on the instrument, the *AutoPowerOff* function can be disabled by holding the HOLD key down (please see the ON-OFF key description).



### **UNIT key**

In measurement mode, it allows selection of the unit of measurement of the pressure, wind speed and calculated flow rate (shown in the central line of the display). By repeatedly pressing the key, the different units of measurement are displayed in sequence: Pa, mbar, mmH<sub>2</sub>O, PSI for the differential pressure, m/s, km/h, ft/m, mph, knot for the wind speed and l/s, m<sup>3</sup>/h, cfm for the flow rate.

This setting changes the information displayed and, for the HD2114P.2 and HD2134P.2 models the immediate print of data (SERIAL key).

**The data recorded using the LOG function (HD2114P.2 and HD2134P.2) keep the chosen unit of measurement displayed during logging.**

**The unit of measurement associated with the data sent to the printer or PC through the serial port using the SERIAL function (HD2114P.2 and HD2134P.2), must be selected before starting the print function.**



### °C/°F - ESC key

The measured temperature value is used to compensate the wind speed measurement. When the temperature probe is connected, the key changes the unit of measurement from degrees Celsius to Fahrenheit.

If the probe is not present, the compensation temperature must be entered manually: to manually change the value shown in the display lower line, press °C/°F once. The temperature indicated starts blinking. While the display is blinking, it is possible to change the compensation temperature in the -200...+600°C range using the arrows (▲ and ▼). Confirm using ENTER. The display stops blinking, and that temperature is used for compensation.

If the temperature probe is not present, to change the unit of measurement between °C and °F, it is necessary to press **twice** the °C/°F key.



### REL/▼ key

In measurement mode, it displays the difference between the current value and that measured on pressing the key for both measurements - main and secondary. The **REL** message appears on the display; press the key again to return to the current measurement. The REL function is not applied to manual temperature: if the thermocouple probe is not present, on pressing REL the error indication ERR appears.

When used in the menu, it decreases the current variable value.



### MENU Key

The first menu item is accessed by initially pressing on the MENU key; press ENTER to go to the following items. To modify the item displayed, use the arrow keys (▲ and ▼). The current value is confirmed by pressing the ENTER key and the display moves on to the next parameter. If pressing ESC the setting is cancelled.

To exit the menu, press the MENU key at any time.

The menu items are listed in this order:

- 1) **Differential pressure resetting:** the most sensitive pressure sensors are affected by an error linked to their position. By rotating the instrument from the horizontal to the vertical position there is a variation in the measurement of a few Pascals. This is the reason the reset command was designed for the differential value: leave the inputs of each probe open so that they detect the same pressure and place the instrument in the position that will be used to perform the measurement. When entering the menu, the "PRES\_REL\_TO\_ZERO ENTR\_TO\_MENU" message appears: press REL to reset the difference or press ENTER to access other menu items. To guarantee the accuracy of maximum results, do not modify the instrument's position compared to that used during the resetting.
- 2) **Pressure probe bottom scale:** the pressure sensor bottom scale is presented.
- 3) **SECT m<sup>2</sup> - SECT inch<sup>2</sup>:** this parameter defines a duct's **section area** for flow rate calculation. It is expressed in m<sup>2</sup> or inch<sup>2</sup>. To change the unit of measurement, press UNIT.

Use the arrows and confirm with ENTER. Please see the paragraph dedicated to wind speed measurement on page 14.

- 4) **Pres Baro (barometric pressure):** the wind speed detected by the Pitot tube is the result of different factors. Among these is the atmospheric pressure resulting from the formula reported on page 15. Using the arrows, enter the atmospheric pressure value present during the measurement. If the current pressure is not known, leave the parameter at the default value of 1013mbar.
- 5) **Pres Stat (Static pressure):** static pressure present in the measured duct. It is referred to the atmospheric pressure and is expressed in mbar. If the duct is open, in contact with the atmosphere, its value is set to zero (default value). If the duct is closed, the pressure difference compared to the atmospheric pressure, expressed in mbar, must be entered. **In order to avoid the sensor breakage, do not use the Pitot tube if the static pressure exceeds the overpressure limit reported in the technical characteristics.**
- 6) **Cost\_PIT\_DARC (constant of Pitot or Darcy tube):** using the arrows, enter the tube constant value. The value can be set from 0.80 to 1.20. If the constant is not known, enter 1.00 for Pitot tubes and 0.84 for Darcy tubes. The set value is displayed when the instrument is turned on.
- 7) **AVG TIME SECS: time interval according to which the moving average is calculated,** in seconds, during measurement of the flow. The value ranges from 1 (no average) to 99 seconds. Please see the paragraph dedicated to wind speed measurement on page 14.
- 8) **Management of memorized data (only HD2114P.2 and HD2134P.2):** the message ">>>\_LOG\_DUMP\_or\_ERAS" (**Transfer data or erase**) is scrolled in the comment line. The center figure reports the number of free memory pages (FREE). All memory data are permanently erased by pressing SERIAL/EraseLOG. By pressing LOG/DumpLOG, the data transfer of the logged data on the serial port is started: the "BAUD-RATE" must have previously been set to the maximum value (please see the menu items described below and the paragraph "STORING AND TRANSFERRING DATA TO A PERSONAL COMPUTER" on page 27).
- 9) **Print and log interval (only HD2114P.2 and HD2134P.2):** sets the interval in seconds between two loggings or data transfers to the serial port. The interval can be set at 0, 1s, 5s, 10s, 15s, 30s, 60s (1min), 120s (2min), 300s (5min), 600s (10min), 900s (15min), 1200s (20min), 1800s (30min) and 3600s (1hour). **If the value 0 is set, SERIAL works on command: the sending of data to the serial port is performed each time the key is pressed.** Recording (LOG) is performed with one second intervals even if the interval is set to 0. With an interval from 1 to 3600s, continuous data transfer is started when the SERIAL key is pressed. To end the recording (LOG) and **continuous** data transfer operations (SERIAL with an interval greater than 0), press the same key again.
- 10) **Sleep\_Mode\_LOG (Automatic turning off during recording) (only HD2114P.2 and HD2134P.2):** this function controls the instrument's automatic turning off during logging, occurring between the capture of a sample and the next one. When the interval is lower than 60 seconds, the instrument will always remain on. With intervals greater than or equal to 60 seconds, it is possible to turn off the instrument between loggings: it will turn on at the moment of sampling and will turn off immediately afterwards, thus increasing the battery life. Using the arrows select **YES** and confirm using **ENTER** in order to enable the automatic turning off, select **NO** and confirm to disable it and keep the instrument on continuously.  
**Note:** even if **Sleep\_Mode\_LOG=YES** is selected, the instrument does not turn off for less than one minute intervals.

- 11) **YEAR (only HD2114P.2 and HD2134P.2):** to set the current year. Use the arrows to modify this parameter and confirm using ENTER.
- 12) **MNTH (month) (only HD2114P.2 and HD2134P.2):** to set the current month. Use the arrows to modify this parameter and confirm using ENTER.
- 13) **DAY (only HD2114P.2 and HD2134P.2):** to set the current day. Use the arrows to modify this parameter and confirm using ENTER.
- 14) **HOUR (only HD2114P.2 and HD2134P.2):** to set the current hour. Use the arrows to modify this parameter and confirm using ENTER.
- 15) **MIN (only HD2114P.2 and HD2134P.2):** to set the current minutes. In order to correctly synchronize the minute, it is possible to reset the seconds by pressing the UNIT key. Use the arrows to set the current minute plus one, and as soon as that minute is reached press UNIT: this synchronizes the time to the second. Press ENTER to go onto the next item.
- 16) **BAUD\_RATE (only HD2114P.2 and HD2134P.2):** indicates the frequency used, expressed in kHz, for the serial communication with the PC. Values from 1.2 (1200 baud) to 38.4 (38400baud). Use the arrows to modify this parameter and confirm using ENTER. **The communication between instrument and PC (or serial port printer) only works if the instrument and PC baud rates are the same.** If the USB connection is used this parameter value is automatically set (please see the details on page 27).



#### LOG/DumpLOG key - only HD2114P.2 and HD2134P.2

In measurement mode, this function starts and stops the logging of a data block to be saved in the instrument's internal memory. The data logging frequency is set in the "**Print and log interval**" menu parameter. The data logged between a start and subsequent stop represent a block.

When the logging function is on, the LOG indication is displayed, the battery symbol blinks and a beep is issued each time a logging occurs; **the battery symbol does not appear when using an external power supply.**

To end the logging, press LOG.

The HD2114P.2 and HD2134P.2 can turn off during logging between one capture and the next: the function is controlled by the **Sleep\_Mode\_LOG** parameter. When the logging interval is less than one minute, the logging instrument remains on; with an interval of at least one minute, it turns off between one capture and the next if the parameter **Sleep\_Mode\_LOG=YES**.



#### Dump LOG - only HD2114P.2 and HD2134P.2

Press the MENU key until the ">>>\_LOG\_DUMP\_or\_ERAS" item is displayed and then press on the LOG key: the transfer of the data contained in the instrument internal memory via the serial port is started.

Please see the paragraph dedicated to data transfer on page 27.

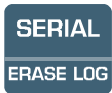

### SERIAL/EraserLOG key - only HD2114P.2 and HD2134P.2

In measurement mode, this function starts and stops the data transfer to the serial output. According to the settings entered in the **Print and log interval** menu item, a single sample can be printed if **Print and log interval=0** or a continuous indefinite printing of the measured data can be set up if **Print and log interval=1...3600**. The printing operation is accompanied by the display of the RS232 symbol and the blinking of the battery symbol; **when using an external power supply the battery symbol does not appear**. Press SERIAL to end the continuous printing.

Before starting the printing via the RS232C port, set the baud rate. To do so, select the **Baud Rate** menu item and select the maximum value equal to 38400 baud by using the arrows. Confirm by pressing ENTER.

The DeltaLog9 software for PC will automatically set the baud rate value during connection. **If you are using a different program than DeltaLog9, be sure the baud rate is the same for both the instrument and the PC: the communication will only work in this way.**

The USB 2.0 connection does not require the baud rate setting as it is automatically managed by the application.



>>>



### Eraser memory - only HD2114P.2 and HD2134P.2

Press the MENU key until the ">>>\_LOG\_DUMP\_or\_ERAS" item is displayed and then press on the SERIAL/EraserLOG key: this clears **permanently** all the data contained in the instrument's memory.

## THE PROBES

The HD2114P.0 and HD2114P.2 instruments are fitted with a 20mbar differential pressure sensor compared to an atmosphere, the HD2134P.0 and HD2134P.2 models have a 200mbar sensor. Any type of Pitot tube with relevant thermocouple K can be connected to the instruments to measure the incident wind speed and calculated flow rate.

In standard temperature and atmospheric pressure conditions, the HD2114P.0 and HD2114P.2 measures speeds up to **55m/s**, the HD2134P.0 and HD2134P.2 up to **180m/s**. All models measure air temperature through the thermocouple K.

The measurement provided by the instruments are:

- Pv differential pressure
- wind speed
- calculated flow rate
- air temperature detected by the thermocouple.

To choose the instantaneous value unit of measurement, press UNIT/DuctCALC.

- for differential pressure: Pa, mbar, mmH<sub>2</sub>O and PSI
- for wind speed: m/s, Km/h, ft/min, mph and knots
- for flow rate: l/s, m<sup>3</sup>/h and ft<sup>3</sup>/min
- for temperature: °C and °F;

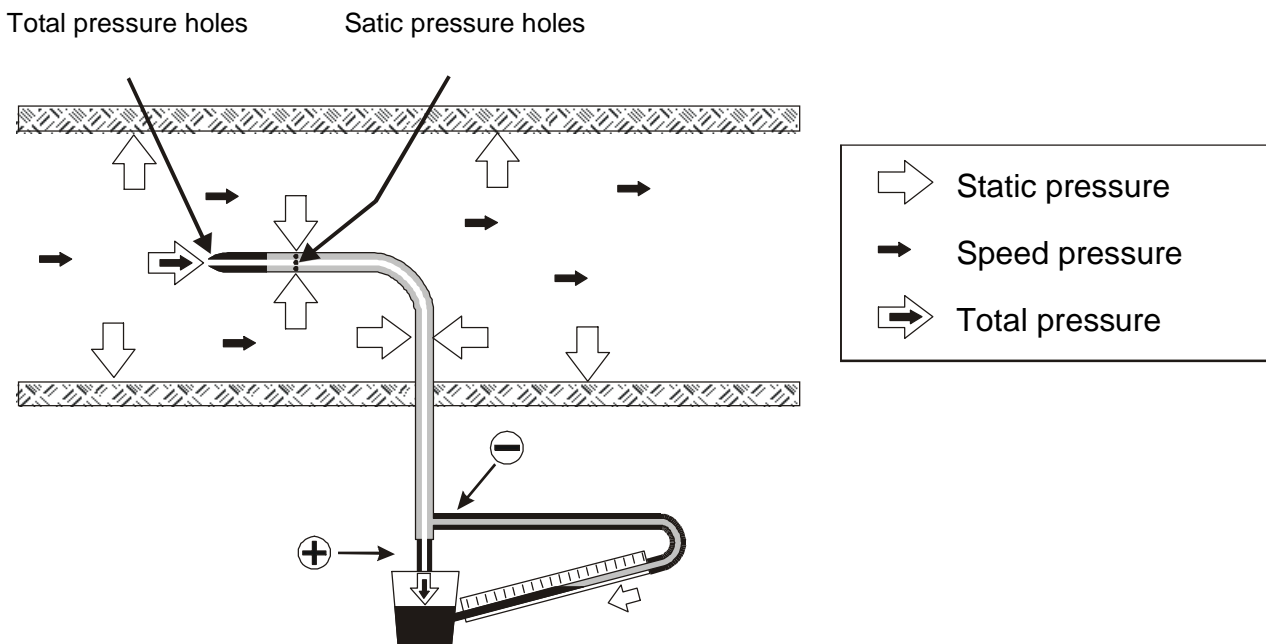

The pressure inside the duct is the result of three different pressures:

- 1) atmospheric pressure (barometric B)
- 2) static pressure Ps
- 3) dynamic pressure Pv caused by the not-nil wind speed inside the duct.

The following relationship gives the wind speed: as you can see this is dependent on the three pressures and the air temperature.

$$(1) \quad v = C \cdot 1.291 \cdot \sqrt{\left[ \frac{1000}{B} \cdot \frac{T}{289} \cdot \frac{100.000}{100.000 + P_s} \cdot P_v \right]}$$

[v] = m/s  
 [B] = mbar  
 [Pv] = [Ps] = Pa  
 [T] = °K

The Pitot tube gives the difference between the pressure present at the front entrance and that detected from the lateral holes, that is, the dynamic pressure **Pv**:

$$(P_s + P_v) - P_s = P_v$$

The static pressure **Ps** represents the pressure difference between the duct internal side in static conditions and the barometric pressure. This parameter can be set using the "PRES STAT" menu item (please see the menu description on page 10). The default value is zero and, if not known, should not be modified.

**B** represents the barometric pressure present during the measurement: The factory default is 1013mbar. This parameter can be set using the "PRES BARO" menu item (please see the menu description on page 10).

**T** is the temperature detected by the thermocouple K present in some Pitot tube models. If the tube is not fitted with one, an external thermocouple K probe with miniature connector can be attached at the Pitot tube input. As an alternative, the compensation temperature value can be entered manually within the -200...+600°C range: please see the °C/°F-ESC key description on page 10.

**C** is the tube constant. This parameter can be set using the "Cost\_PIT\_DARC" menu item (please see the menu description on page 10).

## OPERATION

Connect the Pitot tube outputs (pressure and thermocouple) to the instrument inputs.

The Pitot tube outputs must be connected to the instrument inputs, in agreement with the correct polarity. The Pitot tube downward output, marked in the figure with the sign (+), must be connected to the positive connection on the left of the instrument head; the Pitot tube lateral output, marked in the figure with the sign (-) must be connected to the connection on the right of the instrument head.

Introduce the Pitot tube in the air flow being measured, maintaining the rod at the tube base parallel to the flow as indicated in the following figure.

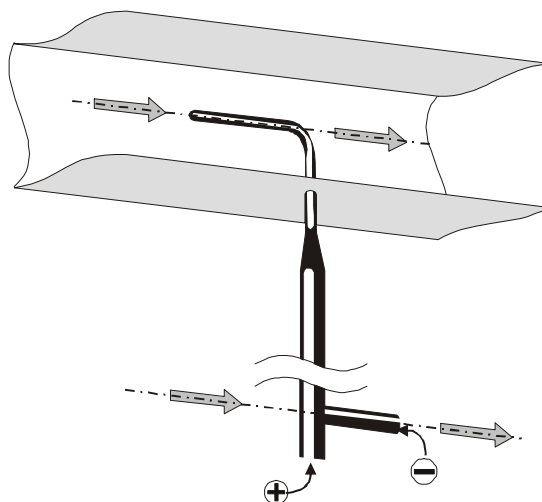

The error reported in case of misalignment is reported in the following graph:

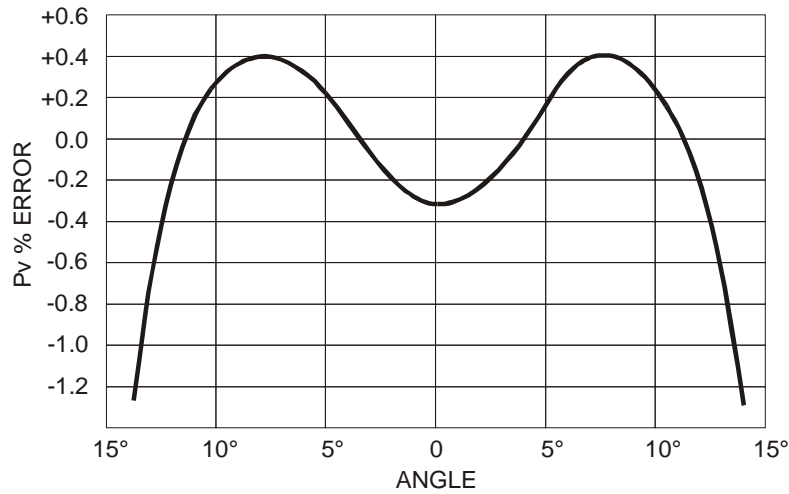

The abscissas reports the rotation angle around its vertical axis compared to the flow direction (yawing), in ordinates the % error on the differential pressure Pv measurement. As you can see a difference of over 10° entails an error on the differential pressure Pv measurement of less than 0.5%.

#### DIMENSIONS OF PITOT TUBES

	T1-...	T2-...	T3-...	T4-...	
Diameter d (mm)	3	5	8	10	
Tip length t (mm)	33	55	88	135	
Length L (mm)	300	400 600	500 800	500 800 1000	
Order Code (*)	T1-300	T2-400 T2-600	T3-500 T3-800 T3-800TC	T4-500 T4-800 T4-800TC T4-1000 T4-1000TC	

(\*) TC = Pitot tubes with K thermocouple

#### FLOW RATE MEASUREMENT

The flow rate measurement requires knowledge of the duct or vent area orthogonal to the flow: the menu items indicated by "SECT m2" and "SECT INC2" define the section area m<sup>2</sup> or inch<sup>2</sup>. To set the area value, select the "SECT m2" menu item, and using the arrows, set the desired value in m<sup>2</sup>. Confirm the selection by pressing the ENTER key.



To set the measurement in  $\text{inch}^2$ , select the "SECT m2" menu item, and using the UNIT key, change the unit of measurement from  $\text{m}^2$  to  $\text{inch}^2$ . Proceed to enter the data using the arrows: confirm with ENTER. The area inserted as above remains in the memory so the flow rate measurements can be repeated on other identical vents, without having to set the area again.

**The area comprised must be between  $0.0001\text{m}^2$  ( $1\text{cm}^2$ ) and  $1.9999\text{m}^2$ .**

After input of the duct's section area, select the unit of measurement for the flow rate by using the UNIT/DuctCALC key: l/s,  $\text{m}^3/\text{h}$  and  $\text{ft}^3/\text{min}$ . **The display shows the calculated flow rate on the section set** with the parameters "SECT m2" and "SECT INC2".

To obtain the correct flow rate measurement, the fact that the air speed is not constant on the section but varies from point to point needs to be considered, therefore an **average** speed over the entire section is required. Furthermore, the speed varies through time at the same point.

This is particularly true when the surface considered is wide or when turbulence is generated, near a grid or diffuser. The anemometers provide some solutions in order to obtain correct measurements even in presence of these disturbance phenomena.

#### 1) *Spatial averaging (Duct Calc function)*

It is always best to perform the measurements at different points and consider the average value as the valid data. Using the *Duct Calc* function (sub-function of the UNIT key), these anemometers can capture more than one measurement and supply the maximum, average, and minimum value. In particular, the average value (AVG) is the most important as it supplies the average speed, and therefore the calculated flow rate **along the entire section** and not on a single measurement point.

#### **Procedure:**

Using the UNIT key, select the **speed** or **flow rate** unit of measurement for which you wish to obtain the average, maximum, and minimum.

Enable the calculation function by pressing simultaneously the UNIT/DuctCALC and FUNC/Enter keys: the central line of the display shows the instantaneous value of the selected variable (**speed or calculated flow rate**) while the lower line figure indicates the number of times the measurement has been logged.

The measurement can be interrupted and there are no time limits to abide by between two subsequent measurements. The captured values are not erased, so it is possible to get some samples, turn the instrument off and later turn it back on again to proceed with the logging of more samples without losing the measurements already carried out. The maximum number of samples is 99.

To reset the calculation, before enabling the Duct Calc function, press FUNC until the message "FUNC CLR" appears, then use the arrows to select YES and confirm using ENTER.

Position the probe in the first measurement point and press HOLD/▲ to capture the first point value.

Repeat the same procedure with all the other points that you feel it is necessary to capture, by pressing HOLD/▲ each time: the indicator will provide the total number of acquired samples. After recording the first sample or at the end of the capture, press FUNC/ENTER. The MAX, MIN and average values of the chosen quantity, that is, **the speed or calculated flow rate on the entire section** will be displayed, according to the variable selected at the beginning of the measurement.

To end the function, press ESC.

**Generally, the greater the number of captured measurements (maximum 99) the greater the accuracy of the result obtained.**

## 2) Moving average

The Duct Calc function provides a spatial averaging of the captured values and therefore compensates the speed differences between one point and another in the duct section. There is also another source of errors due to the variation of the flow **in time**: that is, the flow is not constant but increases or decreases **in the same point**. To compensate for this second source of instability, it is possible to get a temporal moving average of the last **n** measurements capture: with  $n > 1$ , the displayed value will not be the single captured value but the continuously updated current average of the last **n** measurements.

To set the "n" value, use the **AVG TIME SECS** menu function: by using the arrows select the desired **n** value and confirm with ENTER. "n" can be set from 1 (no average) to 99.

**Important: the nominal bottom scales of internal sensors (20, 200mbar) are referred to atmospheric pressure**, therefore on each of the two inputs no relative pressure exceeding the maximum stated overpressure should be applied. Each of the two sensor inputs can bear without breaking—**but without measuring**—the overpressures reported in the following table:

	HD2114P.0 - HD2114P.2	HD2134P.0 - HD2134P.2
Measurement range	±20mbar	±200mbar
Maximum overpressure	±300mbar	±1bar

Some units of measurement require a degree of multiplication: the "-3" symbol indicates the displayed value must be divided by 1,000; the "3" and "6" symbols indicate the displayed value must be multiplied respectively by 1,000 or by 1,000,000.

## TEMPERATURE MEASUREMENT

The instruments can be used as thermometers, can be employed with any kind of thermocouple K probe if using a standard miniature connector. The instrument's measuring range in the thermometer version is -200...+1370°C.

The contacts of the thermocouple probe connector are polarized. They must be inserted on the standard miniature socket located on the instrument in the correct direction. These probes are usually marked with a + and – sign: These symbols must coincide with the corresponding symbols located on the instrument's rubber protection.

The user can choose the unit of measurement for display, printing and logging among the allowed ones: °C or °F.

In all versions the thermocouple sensitive element (hot junction) is housed in the end part of the probe.

The response time for the measurement of the temperature in **air** is greatly reduced if the air is moving. If the air is still, stir the probe. The response times are longer than those for liquid measurements.

The temperature measurement by **immersion** is carried out by inserting the probe in the liquid for at least 60mm; the hot junction is housed in the end part of the probe.

In the temperature measurement by **penetration** the probe tip must be inserted to a depth of at least 60mm, the hot junction is housed in the end part of the probe. When measuring the temperature on frozen blocks it is convenient to use a mechanical tool to bore a cavity in which to insert the tip probe.

In order to perform a correct **contact** measurement, the measurement surface must be even and smooth, and the probe must be perpendicular to the measurement plane. A contact measurement is hard to perform due to various factors: the operator must be experienced in handling the probe and consider all the factors influencing it.

**So as to obtain the correct measurement, the insertion of a drop of oil or heat-conductive paste is useful (do not use water or solvents). This method also improves the response time.**

## WARNINGS AND OPERATING INSTRUCTIONS

1. Do not expose the probes to gases or liquids that could corrode the material of the sensor or the probe itself. Clean the probe carefully after each measurement. **The pressure sensor is suitable for measurement of only non corrosive dry gases or air and not liquid:** check the membrane compatibility with the plant fluid.
2. Do not bend the probe connectors or force them upward or downward. Do not bend or force the contacts when inserting the probe connector into the instrument.
3. Do not bend, deform or drop the probes, as this could cause irreparable damage.
4. Always select the most suitable probe for your application.
5. Comply with the correct polarity of the probes.
6. In general, do not use temperature probes in presence of corrosive gases or liquids; the probe external containers are made of AISI 316 or INCONEL stainless steel, while the contact probe containers are made of AISI 316 or INCONEL stainless steel plus silver. Avoid contact between the probe surface and any sticky surface or substance that could corrode or damage it.
7. To obtain reliable measurements, temperature variations that are too rapid must be avoided.
8. Temperature probes for surface measurements (contact probes) must be held perpendicular against the surface. Apply oil or heat-conductive paste between the surface and the probe in order to improve contact and reduce reading time. Whatever you do, do not use water or solvent for this purpose. A contact measurement is always very hard to perform. It has high levels of uncertainty and depends on the ability of the operator.
9. Temperature measurements on non-metal surfaces usually require a great deal of time due to the low heat conductivity of non-metal materials.
10. **Probes are not insulated from their external casing;** be very careful not to come into contact with live parts (above 48V). This could be extremely dangerous for the instrument as well as for the operator, who could be electrocuted.  

11. Avoid taking measurements in presence of high frequency sources, microwave ovens or large magnetic fields; results may not be very reliable.
12. Clean the probe carefully after use. Clean the sensor pressure chamber carefully. Avoid deposits or incrustations left by the fluid coming into contact with the membrane, as with time this could cause measurement errors.
13. Avoid inserting nails or spikes into the pressure chamber as the membrane could be unintentionally torn.
14. In order to fix the probes, use a suitable fixed wrench, and possibly sealing gaskets.
15. The instrument is water resistant and IP66, but is not watertight and therefore should not be immersed in water without closing the free connectors using caps. The probe connectors must be fitted with sealing gaskets. Should the instrument fall into the water, check for any water infiltration. Gently handle the instrument in such a way as to prevent any water infiltration from the quick couplings' side.

## INSTRUMENT SIGNALS AND FAULTS

The following table lists all error indications and information displayed by the instrument and supplied to the user in different operating situations.

Display indications	Explanation
<b>ERR</b>	This appears if the pressure sensor detects a value exceeding the limit of 125% of the bottom scale nominal value.
<b>OVER</b>	Measurement overflow: this appears if the pressure sensor exceeds the limit of 120% of the bottom scale nominal value. Over 125%, the display indicates ERR. Measurement overflow: this appears if the external temperature probe is measuring a value exceeding the set measuring range.
<b>LOG MEM FULL</b>	Memory full; the instrument cannot store further data, the memory space is exhausted.
<b>SYS ERR #</b>	Instrument management program error. Contact the instrument's supplier and communicate the numeric code # reported by the display.
<b>CAL LOST</b>	Program error: it appears after turning on for a few seconds. Contact the instrument's supplier.
<b>BATT TOO LOW CHNG NOW</b>	Indication of insufficient battery charge appearing on turning on. The instrument issues a long beep and turns off. Replace the batteries.

The following table reports the indications provided by the instrument as they appear on the display, together with their description.

Display indication	Explanation
>>> LOG_DUMP_or_ERAS	transfer or erase data
20 mBAR DIFF	probe 20mbar differential
200 mBAR DIFF	probe 200mbar differential
AVG TIME SECS	moving average in seconds
BATT TOO LOW - CHNG NOW	battery discharged - replace it immediately
BAUDRATE >>>	baud rate value
COMM STOP	printing complete
COMM STRT	printing started
coSt or coSt_PIT_DARC	constant of Pitot or Darcy tube
DAY_	day
DUCT MODE	flow rate calculation mode
DUMP_END	data transfer complete
DUMP_In_PROG >>>	data transfer in progress
ERR	error
FUNC CLR	max, min and average values clearing
FUNC CLRD	max, min and average values cleared
HOUR	hour
LOG In PROG	logging in progress
LOG MEM FULL	memory full
LOG_CLRD	memory data cleared
LOG_STOP	logging complete
LOG_STRT	logging started
MIN >>> USE_UNIT_TO_ZERO SEC	minutes >>> use the UNIT key to reset the seconds
MNTH	month
OVER	maximum limit of temperature or pressure exceeded
PLS_EXIT >>> FUNC RES_FOR_FACT ONLY	please exit using ESC >>> function reserved to factory calibration
PRES BARO	barometric pressure
PRES STAT	static pressure
PRES_REL_TO_ZERO ENTR_TO_MENU	press REL to reset differential probe or ENTER to access menu
PRNT AND LOG INTV	printing and logging intervals
PRNT INTV >>>	printing interval
SECT Inch <sup>2</sup>	duct section in inch <sup>2</sup>
SECT_m <sup>2</sup> _	duct section in m <sup>2</sup>
SLP_MODE_LOG	turning off during recording mode
SYS ERR #	program error number #
YEAR	year

## LOW BATTERY WARNING AND BATTERY REPLACEMENT

The battery symbol  on the display constantly shows the battery charge status. To the extent that batteries have discharged, the symbol "empties". When the charge decreases still further it starts blinking...

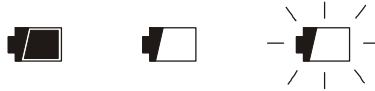

In this case, batteries should be replaced as soon as possible.

If you continue to use it, the instrument can no longer ensure correct measurement. The memory data are maintained.

**If the battery charge level is insufficient, the following message appears when you turn the instrument on:**

**BATT TOO LOW  
CHNG NOW**

**The instrument issues a long beep and turns off. In this case, replace the batteries in order to turn the instrument back on.**

**In order to avoid data loss, the logging session is ended, if the HD2114P.2 or HD2134P.2 are logging and battery voltage falls below the minimum operating level.**

In the HD2114P.2 and HD2134P.2, the battery symbol turns off when the external power supply is connected.

To replace the batteries, switch the instrument off and unscrew the battery cover counter clockwise. After replacing the batteries (4 1.5V alkaline batteries - type AA) screw the cover on clockwise.



**After replacing the batteries, the date, time, baud rate, type of probe, printing interval, logging parameters must be set again: in order to simplify the operation, on insertion of the new batteries the instrument turns on automatically and requests these parameters in sequence.** To go to the next item press ENTER; to return to measurement mode, press MENU.

## **MALFUNCTIONING UPON TURNING ON AFTER BATTERY REPLACEMENT**

After replacing the batteries, the instrument may not restart correctly; in this case, repeat the operation. After disconnecting the batteries, wait a few minutes in order to allow circuit condensers to discharge completely; then reinsert the batteries.

## **WARNING ABOUT BATTERY USE**

- Batteries should be removed when the instrument is not used for an extended time.
- Flat batteries must be replaced immediately.
- Avoid batteries leaking.
- Always use good quality leakproof alkaline batteries. Sometimes on the market, it is possible to find new batteries with an insufficient charge capacity.

## **INSTRUMENT STORAGE**

Instrument storage conditions:

- Temperature: -25...+65°C.
- Humidity: less than 90%RH without condensation.
- Do not store the instrument in places where:
  - Humidity is high.
  - The instrument may be exposed to direct sunlight.
  - The instrument may be exposed to a source of high temperature.
  - The instrument may be exposed to strong vibrations.
  - The instrument may be exposed to steam, salt or any corrosive gas.

The instrument case is made of ABS plastic and the protections are rubber: do not use any incompatible solvent for cleaning.



## SERIAL INTERFACE AND USB

The **HD2114P.2** and **HD2134P.2** instruments are fitted with an electrically isolated RS-232C serial interface, and an USB 2.0 interface.

The following serial cables can be used:

- **HD2110CSNM**: serial connection cable with 8-pole MiniDin connector on one end and 9-pole Sub D connector on the other end;
- **C.206**: serial connection cable with 8-pole MiniDin connector on one end and USB type A connector on the other end. With integrated RS232/USB converter;
- **CP23**: connection cable with Mini-USB type B connector on one end and USB type A connector on the other end.

The connection via the C.206 cable requires the previous installation of the cable USB drivers. Install the drivers **before connecting the C.206 cable to the PC**.

The connection via the CP23 cable does not require the installation of USB drivers: when connecting the instrument to the PC, the Windows® operating system automatically recognizes the device as an HID device (Human Interface Device) and uses the drivers already included in the operating system.

Cable	Instrument port	PC port	Installation of USB drivers
HD2110CSNM	RS232 (MiniDin)	RS232 (9-pole SubD)	No
C.206	RS232 (MiniDin)	USB	Yes
CP23	USB (Mini-USB)	USB	No

The instrument standard serial transmission parameters are:

- Baud rate 38400 baud
- Parity None
- N. bit 8
- Stop bit 1
- Protocol Xon/Xoff

It is possible to change the RS232C serial port baud rate by setting the "*Baudrate*" parameter in the menu (please see page 12). The possible values are: 38400, 19200, 9600, 4800, 2400, 1200. The other transmission parameters are fixed.

The USB 2.0 connection does not require the setting of parameters.

The instruments are provided with a complete set of commands and data queries to be sent via the PC. The serial commands work with a standard serial communication program (e.g. Hyperterminal) only through the RS232 serial port of the instrument, using the cable HD2110CSNM or the cable C.206.

All the commands transferred to the instrument must have the following structure:  
**XYcr** where: **XY** is the command code and **cr** is the Carriage Return (ASCII 0D)

Command	Response	Description
P0	&	Ping (locks the instrument keyboard for 70 seconds)
P1	&	Unlocks the instrument keyboard
S0	53.42 22.7	Captured measurements (24 characters)
G0	Model HD2114P -2	Instrument model

Command	Response	Description
G1	M=Pitot Micromanometer	Model description
G2	SN=12345678	Instrument serial number
G3	Firm.Ver.=01-00	Firmware version
G4	Firm.Date=2004/10/15	Firmware date
G5	cal 0000/00/00 00:00:00	Calibration date and time
G6	Probe=20mbar	Type of probe connected to input
G7	Probe SN=11119999	Probe serial number
G8	Probe cal.=not present	Probe calibration date
GB	User ID=0000000000000000	User code (set with T2xxxxxxxxxxxxxxxxxx)
GC		Print instrument's heading
LN	&1999	Number of free pages in the flash memory
LD	PRINTOUT OF LOG	Print data logged in flash
LE	&	Erase data in flash memory
K1	PRINTOUT IMMEDIATE MODE	Immediate printing of data
K0		Stop printing data
K4	&	Start logging data
K5	&	Stop logging data
K7	&	Enable REL function
K6	&	Disable REL function
KP	&	Auto-power-off function=ENABLE
KQ	&	Auto-power-off function=DISABLE
KZ	&	Differential probes reset function
RA	& #	Reading of LOG/PRINT interval set
RP	& 600	Battery level (Resolut. 0.01V)
RUA	U= Pa	Main unit of measurement
RUB	U= °C	Secondary unit of measurement
WA#	&	Setting LOG/PRINT interval. # is a hexadecimal number 0...D that represents the position of the interval in the list 0, 1, 5, 10, ..., 3600 seconds.
WC0	&	Setting SELF off
WC1	&	Setting SELF on

Command characters are exclusively upper case characters. Once a correct command is entered, the instrument responds with "&"; when any wrong combination of characters is entered, the instrument responds with "?". The instrument response strings end with the sending of the CR command (Carriage Return). The instrument does not send the LF command (Line Feed).

Before sending commands to the instrument via the serial port, locking the keyboard to avoid functioning conflicts is recommended: use the P0 command. When complete, restore the keyboard with the P1 command.

## STORING AND TRANSFERRING DATA TO A PERSONAL COMPUTER

The **HD2114P.2** and **HD2134P.2** instruments can be connected to a personal computer via an RS232C serial port or an USB 2.0 port, and exchange data and information through the DeltaLog9 software running in a Windows operating environment. The models can send in real time input measured values directly to a PC, through the PRINT function, or even store the values measured by using the *Logging* function (LOG key) in their internal memory. If necessary, the data stored in the memory can be transferred to a PC later.

### THE LOGGING FUNCTION - ONLY FOR HD2114P.2 AND HD2134P.2

The *Logging* function allows the recording up to 36000 measurements registered by the probe connected to the inputs. The time interval between two consecutive measurements can be set from 1 second to 1 hour. The logging starts by pressing the LOG key and ends by pressing the same key again: the data memorized in this way form a continuous block of data.

See the description of the menu items on page 10.

If the automatic turning off option between two recordings (MENU >> **Sleep\_Mode\_LOG**) is enabled, upon pressing the LOG key the instrument logs the first data and turns off. 15 seconds before the next logging instant, it turns on again to capture the new sample, and then turns off. In this phase, the display will signal that the instrument is logging using the flashing message: "LOG ON".

The data stored in the memory can be transferred to a PC using the DUMP LOG command: MENU key, using ENTER select the ">>>\_LOG\_DUMP\_or\_ERAS" item, and then press on the LOG/DumpLog key. During data transfer the display shows the message DUMP; to stop the data transfer press ESC on the instrument or on the PC.

### CLEARING THE MEMORY - ONLY FOR HD2114P.2 AND HD2134P.2

To clear the memory use the Erase Log function (MENU key, using ENTER select the ">>>\_LOG\_DUMP\_or\_ERAS" item, and then press on the SERIAL/EraseLOG key). The instrument starts clearing the internal memory; at the end of the operation, it goes back to normal display.

#### NOTES:

- Data transfer does not cause the memory to be erased; the operation can be repeated as many times as required.
- The stored data remain in the memory independently of battery charge conditions.
- In order to print the data to a parallel interface printer, you must use a parallel-serial adaptor (not supplied).
- **The direct connection between instrument and printer via a USB connector does not work.**
- Some keys are disabled during logging. The following keys work: HOLD, FUNC (Max-Min-Avg) and SERIAL.
- Pressing the HOLD, REL and FUNC keys has no effect on the logged data if these keys are pressed **after** starting the recording, otherwise the following is valid.
- The recording started with the display in HOLD mode proceeds normally with the actual measured values (that is, not in "HOLD" mode). Only the display is frozen to the values present when the HOLD key was pressed.
- The same is true for the Max-Min-Avg function.
- If the logging is started when the display is in REL mode, the relative values are logged.

- It is possible to activate both the logging (LOG) and direct transfer (PRINT) functions at the same time.

### **THE PRINT FUNCTION - ONLY FOR HD2114P.2 AND HD2134P.2**

The PRINT function sends the measurements taken in real time by the instrument inputs directly to a PC or a printer. Print data units of measurements are the same as those used on the display. The function is started by pressing SERIAL. The time interval between two consecutive prints can be set from 1 second to 1 hour (please see the **Print and log interval** menu item on page 10). If the print interval is equal to 0, by pressing SERIAL the single data is sent to the connected device. If the print interval is higher than 0, the data transfer continues until the operator stops it by pressing SERIAL again.

The PRINT function works with a standard serial communication program (e.g. Hyperterminal) only through the RS232 serial port of the instrument, using the cable HD2110CSNM or the cable C.206.

Connect the HD40.1 printer using cable HD2110CSNM.

#### NOTES:

- The print out is formatted across 24 columns.
- Some keys are disabled during serial transmission. The following keys work: ON/OFF, HOLD, FUNC (Max-Min-Avg) and LOG.
- Pressing the HOLD, REL and FUNC keys has no effect on the printed data if these keys are pressed **after** starting the printing, otherwise the following is valid.
- The serial transfer started with the display in HOLD mode proceeds normally with the actual measured values (that is, not in "HOLD" mode). Only the display is frozen to the values present when the HOLD key was pressed.
- The same is true for the Max-Min-Avg function.
- If the serial transfer is started when the display is in REL mode, the relative values are transferred.
- It is possible to activate both the logging (LOG) and direct transfer (PRINT) functions at the same time.

## CONNECTION TO A PC

### **HD2114P.2 and HD2134P.2**

Connection to the PC with the cable:

- **CP23:** Mini-USB type B connector on one end and USB type A connector on the other end;
- **HD2110CSNM:** 8-pole MiniDin connector on one end and 9-pole Sub D connector on the other end;
- **C.206:** 8-pole MiniDin connector on one end and USB type A connector on the other end. With integrated RS232/USB converter (requires the installation of the USB drivers).

The instruments are supplied with the DeltaLog9 software that manages the connection, data transfer, graphic presentation, and printing operations of the captured or logged measurements.

**The DeltaLog9 software is complete with "On-line Help" (also in PDF format) describing its characteristics and functions.**

### **CONNECTION TO THE RS232C SERIAL PORT OF THE INSTRUMENT - ONLY FOR HD2114P.2 AND HD2134P.2**

1. The measurement instrument must be switched off.
2. Using the Delta Ohm HD2110CSNM or C.206 cable, connect the measurement instrument to the first free RS232C (COM) or USB serial port of the PC.
3. Turn on the instrument and set the baud rate to 38400 (MENU >> ENTER until the Baud Rate parameter >> select 38400 using the arrows >> confirm with ENTER). The parameter remains in the memory until replacement of the batteries.
4. Launch the DeltaLog9 application and press CONNECT. Wait for the connection to occur and follow the indications on the screen. For a description of the DeltaLog9 application, please refer to its on-line Help.

### **CONNECTION TO THE USB 2.0 PORT OF THE INSTRUMENT - ONLY FOR HD2114P.2 AND HD2134P.2**

The connection via the CP23 cable does not require the installation of USB drivers: when connecting the instrument to the PC, the Windows® operating system automatically recognizes the device as an HID device (Human Interface Device) and uses the drivers already included in the operating system.

To check if the connection has been successfully completed, double-click on "*Device Manager*" from the Control Panel. The following items should appear:

*"Human Interface Device" >> "HID-compliant device"*

*"Human Interface Device" >> "USB Human Interface Device"*

When the USB cable is disconnected, the items disappear and reappear when it is connected again.

## NOTES ABOUT WORKING AND OPERATIVE SAFETY

### Authorized use

The technical specifications as given in chapter "TECHNICAL CHARACTERISTICS" must be observed. Only the operation and running of the measuring instrument according to the instructions given in this operating manual is authorized. Any other use is considered unauthorized.

### General safety instructions

This measuring system is constructed and tested in compliance with the EN 61010-1:2010 safety regulations for electronic measuring instruments. It left the factory in a safe and secure technical condition.

The smooth functioning and operational safety of the measuring system can only be guaranteed if the generally applicable safety measures and the specific safety instructions in this operating manual are followed during operation.

The smooth functioning and operational safety of the instrument can only be guaranteed under the environmental and electrical operating conditions that are in specified in chapter "TECHNICAL CHARACTERISTICS".

Do not use or store the product in places such as listed below:

- Rapid changes in ambient temperature which may cause condensation.
- Corrosive or inflammable gases.
- Direct vibration or shock to the instrument.
- Excessive induction noise, static electricity, magnetic fields or noise.

If the measuring system was transported from a cold environment to a warm environment, the formation of condensate can impair the functioning of the measuring system. In this event, wait until the temperature of the measuring system reaches room temperature before putting the measuring system back into operation.

### Obligations of the purchaser

The purchaser of this measuring system must ensure that the following laws and guidelines are observed when using dangerous substances:

- EEC directives for protective labour legislation
- National protective labour legislation
- Safety regulations

## INSTRUMENT TECHNICAL CHARACTERISTICS

### *Instrument*

Dimensions (Length x Width x Height)	185x90x40mm
Weight	470g (complete with batteries)
Materials	ABS, rubber
Display	2x4½ digits plus symbols Visible area: 52x42mm

### *Operating conditions*

Operating temperature	-5...50°C
Warehouse temperature	-25...65°C
Working relative humidity	0...90% RH without condensation

**Protection degree** **IP66**

### *Power Supply*

Batteries	4 1.5V type AA batteries
Autonomy	200h with 1800mAh alkaline batteries
Power absorbed with instrument off	20µA
Mains (cod. <b>SWD10</b> ) - models <b>HD21x4P.2</b>	Mains adapter 100-240Vac/12Vdc-1A

### *Measuring units*

°C - °F - Pa - mbar - mmH<sub>2</sub>O - PSI - m/s - km/h - ft/min - mph - knot - l/s - m<sup>3</sup>/h - cfm

### *Security of memorized data*

Unlimited, independent of battery charge conditions

### *Time*

Date and time	Schedule in real time
Accuracy	1min/month max drift

### *Measured values storage- models **HD2114P.2** and **HD2134P.2***

Type	2000 pages containing 18 samples each
Quantity	36000 samples
Selectable storage interval	1s, 5s, 10s, 15s, 30s, 1min, 2min, 5min, 10min, 15min, 20min, 30min and 1hour

### *Serial interface RS232C - models **HD2114P.2** and **HD2134P.2***

Type	RS232C electrically isolated
Baud rate	Can be set from 1200 to 38400 baud
Data bit	8
Parity	None
Stop bit	1
Flow Control	Xon/Xoff
Serial cable length	Max 15m
Selectable print interval	immediate or 1s, 5s, 10s, 15s, 30s, 1min, 2min, 5min, 10min, 15min, 20min, 30min and 1hour

USB interface - models **HD2114P.2** and **HD2134P.2**

Type 1.1 - 2.0 electrically isolated

Connections

Pressure inputs 2 quick couplings Ø 5mm  
 TC type K temperature input 2-pole female polarized standard miniature connector

RS232 serial interface - models **HD2114P.2** and **HD2134P.2**  
 8-pole MiniDin connector

USB interface - models **HD2114P.2** and **HD2134P.2**  
 Mini-USB type B connector

Mains adapter (cod. **SWD10**) - models **HD21x4P.2**  
 2-pole connector (positive at centre)

Measurement of pressure, wind speed and flow rate calculated by the internal sensor, and temperature measured using thermocouple K

	<b>HD2114P.0 HD2114P.2</b>	<b>HD2134P.0 HD2134P.2</b>
<i>Measurement range</i>		
Differential pressure	±20mbar	±200mbar
Speed (*)	2 ... 55m/s	3 ... 180m/s
Temperature using thermocouple K	-200...+1370°C	-200...+1370°C
Temperature using Pitot tube	-200...+600°C	-200...+600°C
<i>Maximum overpressure</i>	±300mbar	±1bar
<i>Resolution</i>	Differential pressure 0.005mbar - 0.5Pa   0.01mbar - 1Pa Speed 0.1 m/s - 1 km/h - 1 ft/min - 1 mph - 1 knots Flow rate 1l/s - 0.01·10 <sup>3</sup> m <sup>3</sup> /h - 0.01·10 <sup>3</sup> cfm Temperature 0.1°C	
<i>Accuracy</i>		
Differential pressure	±0.4%f.s.	±0.3%f.s.
Speed	±(2% reading+0.1m/s)	±(2% reading+0.3m/s)
Temperature (**)	±0.1°C	±0.1°C
<i>Minimum speed</i>	2 m/s	3 m/s
<i>Automatic air temperature compensation</i>	-200...+600°C	
<i>Manual air temperature compensation</i>	-200...+600°C	
<i>Unit of Measurement</i>	Differential pressure Pa - mbar - mmH <sub>2</sub> O - PSI Speed m/s – km/h – ft/min – mph - knots Flow rate l/s – m <sup>3</sup> /h – cfm Temperature °C / °F	
<i>Pipeline section for flow rate calculation</i>	0.0001...1.9999 m <sup>2</sup>	
<i>Fluid contacting the membrane</i>	non corrosive dry air and gas	



(\*) At 20°C, 1013mbar and Ps negligible.

(\*\*) The accuracy only refers to the instrument. The error due to the thermocouple or to the cold junction reference sensor is not included.

Temperature drift @ 20°C	0.02%/°C
Drift after 1 year	0.1°C/year

### TYPE K THERMOCOUPLE PROBES

All **thermocouple probes of type K** can be connected to the instruments using the standard miniature connector, which can be found in the price list.

#### Tolerance of the thermocouple probes:

The tolerance of a type of thermocouple corresponds to the maximum acceptable deviation from the e.m.f. of any thermocouple of that type, with reference junction at 0°C. The tolerance is expressed in degrees Celsius, preceded by the sign.

The tolerances refer to the operating temperature expected for the thermocouple, in agreement with the diameter of the thermoelements.

### TOLERANCE CLASSES OF THERMOCOUPLES

Tolerances according to **IEC 60584-2** standard.

The values refer to thermocouples with **reference junction at 0 °C**.

Type of thermocouple	Tolerance class 1		Tolerance class 2		Tolerance class 3	
	Temperature range (°C)	Tolerance (°C)	Temperature range (°C)	Tolerance (°C)	Temperature range (°C)	Tolerance (°C)
<b>B</b>	---	---	+600...+1700	$\pm 0.0025 \cdot t$	+600...+800	$\pm 4$
	---	---	---	---	+800...+1700	$\pm 0.005 \cdot t$
<b>E</b>	-40...+375	$\pm 1.5$	-40...+333	$\pm 2.5$	-167...+40	$\pm 2.5$
	+375...+800	$\pm 0.004 \cdot t$	+333...+900	$\pm 0.0075 \cdot t$	-200...-167	$\pm 0.015 \cdot t$
<b>J</b>	-40...+375	$\pm 1.5$	-40...+333	$\pm 2.5$	---	---
	+375...+750	$\pm 0.004 \cdot t$	+333...+750	$\pm 0.0075 \cdot t$	---	---
<b>K, N</b>	-40...+375	$\pm 1.5$	-40...+333	$\pm 2.5$	-167...+40	$\pm 2.5$
	+375...+1000	$\pm 0.004 \cdot t$	+333...+1200	$\pm 0.0075 \cdot t$	-200...-167	$\pm 0.015 \cdot t$
<b>R, S</b>	0...+1100	$\pm 1$	0...+600	$\pm 1.5$	---	---
	+1100...+1600	$\pm [1+0.003 \cdot (t-1100)]$	+600...+1600	$\pm 0.0025 \cdot t$	---	---
<b>T</b>	-40...+125	$\pm 0.5$	-40...+133	$\pm 1$	-67...+40	$\pm 1$
	+125...+350	$\pm 0.004 \cdot t$	+133...+350	$\pm 0.0075 \cdot t$	-200...-67	$\pm 0.015 \cdot t$

Note: t = temperature of measurement junction in °C.

## ORDER CODES

- HD2114P.0** The kit includes the instrument HD2114P.0 **with 20mbar full scale** and K thermocouple input, 4 x 1.5V alkaline batteries, operating manual, case.
- HD2114P.2** The kit includes the instrument HD2114P.2 **datalogger with 20mbar full scale** and K thermocouple input, 4 x 1.5V alkaline batteries, operating manual, case and DeltaLog9 software.
- HD2134P.0** The kit includes the instrument HD2134P.0 **with 200mbar full scale** and K thermocouple input, 4 x 1.5V alkaline batteries, operating manual, case.
- HD2134P.2** The kit includes the instrument HD2134P.2 **datalogger with 200mbar full scale** and K thermocouple input, 4 x 1.5V alkaline batteries, operating manual, case and DeltaLog9 software.
- PW** Extension with male-female standard miniature connectors to connect the Pitot tube's thermocouple K to the instrument, length 2m.
- HD2110CSNM** Connection cable 8-pole MiniDin – Sub D 9-pole female for RS232C.
- C.206** Connection cable 8-pole MiniDin – USB type A. With integrated RS232/USB converter.
- CP23** Connection cable Mini-USB type B – USB type A.
- DeltaLog9** Software for transfer and management of the data on PC using Windows (from 98) operating systems.
- SWD10** Stabilized power supply at 100-240Vac/12Vdc-1A mains voltage.
- HD40.1** The kit includes: 24-column portable thermal printer, serial interface, 57mm paper width, four NiMH 1.2V rechargeable batteries, SWD10 power supply, instruction manual, 5 thermal paper rolls.
- BAT.40** Spare battery pack for HD40.1 printer with in-built temperature sensor.
- RCT** The kit includes 4 thermal paper rolls 57mm wide and 32mm in diameter.

**The probes and the cables must be ordered separately.**

<b>Pitot tubes</b>	T1-...	T2-...	T3-...	T4-...	
Diameter d (mm)	3	5	8	10	
Tip length t (mm)	33	55	88	135	
Length L (mm)	300	400 600	500 800	500 800 1000	
<b>Order Code (*)</b>	<b>T1-300</b>	<b>T2-400</b> <b>T2-600</b>	<b>T3-500</b> <b>T3-800</b> <b>T3-800TC</b>	<b>T4-500</b> <b>T4-800</b> <b>T4-800TC</b> <b>T4-1000</b> <b>T4-1000TC</b>	

(\*) TC = Pitot tubes with K thermocouple

**DELTA OHM metrology laboratories LAT N° 124 are accredited by ACCREDIA for Temperature, Humidity, Pressure, Photometry / Radiometry, Acoustics and Air Velocity. They can supply calibration certificates for the accredited quantities.**

**DICHIARAZIONE DI CONFORMITÀ UE  
EU DECLARATION OF CONFORMITY****Delta Ohm S.r.L. a socio unico – Via Marconi 5 – 35030 Caselle di Selvazzano – Padova – ITALY**Documento Nr. / Mese.Anno: **5015 / 08.2017**  
Document-No. / Month.Year :

Si dichiara con la presente, in qualità di produttore e sotto la propria responsabilità esclusiva, che i seguenti prodotti sono conformi ai requisiti di protezione definiti nelle direttive del Consiglio Europeo:

*We declare as manufacturer herewith under our sole responsibility that the following products are in compliance with the protection requirements defined in the European Council directives:*Codice prodotto: **HD2114P.0 – HD2114P.2 – HD2134P.0 – HD2134P.2**  
Product identifier :Descrizione prodotto: **Manometro – Termometro termocoppia**  
Product description : **Manometer – Thermocouple thermometer**I prodotti sono conformi alle seguenti Direttive Europee:  
*The products conform to following European Directives:*

Direttive / Directives	
2014/30/EU	Direttiva EMC / EMC Directive
2014/35/EU	Direttiva bassa tensione / Low Voltage Directive
2011/65/EU	RoHS / RoHS

Norme armonizzate applicate o riferimento a specifiche tecniche:  
*Applied harmonized standards or mentioned technical specifications:*

Norme armonizzate / Harmonized standards	
EN 61010-1:2010	Requisiti di sicurezza elettrica / Electrical safety requirements
EN 61326-1:2013	Requisiti EMC / EMC requirements
EN 50581:2012	RoHS / RoHS

Il produttore è responsabile per la dichiarazione rilasciata da:  
*The manufacturer is responsible for the declaration released by:*

Johannes Overhues

Amministratore delegato  
Chief Executive Officer

Caselle di Selvazzano, 03/08/2017

Questa dichiarazione certifica l'accordo con la legislazione armonizzata menzionata, non costituisce tuttavia garanzia delle caratteristiche.

*This declaration certifies the agreement with the harmonization legislation mentioned, contained however no warranty of characteristics.*

# GUARANTEE



Member of GHM GROUP

## TERMS OF GUARANTEE

All DELTA OHM instruments are subject to accurate testing, and are guaranteed for 24 months from the date of purchase. DELTA OHM will repair or replace free of charge the parts that, within the warranty period, shall be deemed non efficient according to its own judgement. Complete replacement is excluded and no damage claims are accepted. The DELTA OHM guarantee only covers instrument repair. The guarantee is void in case of incidental breakage during transport, negligence, misuse, connection to a different voltage than that required for the appliance by the operator. Finally, a product repaired or tampered by unauthorized third parties is excluded from the guarantee. The instrument shall be returned FREE OF SHIPMENT CHARGES to your dealer. The jurisdiction of Padua applies in any dispute.



The electrical and electronic equipment marked with this symbol cannot be disposed of in public landfills. According to the Directive 2011/65/EU, the european users of electrical and electronic equipment can return it to the dealer or manufacturer upon purchase of a new one. The illegal disposal of electrical and electronic equipment is punished with an administrative fine.

This guarantee must be sent together with the instrument to our service centre.

IMPORTANT: Guarantee is valid only if coupon has been correctly filled in all details.

Instrument Code:             HD2114P.0             HD2134P.0  
    HD2114P.2             HD2134P.2

Serial Number \_\_\_\_\_

## RENEWALS

Date \_\_\_\_\_

Date \_\_\_\_\_

Inspector \_\_\_\_\_

Inspector \_\_\_\_\_

Date \_\_\_\_\_

Date \_\_\_\_\_

Inspector \_\_\_\_\_

Inspector \_\_\_\_\_

Date \_\_\_\_\_

Date \_\_\_\_\_

Inspector \_\_\_\_\_

Inspector \_\_\_\_\_



The quality level of our instruments is the result of the constant development of the product. This may produce some differences between the information written in this manual and the instrument you have purchased. We cannot completely exclude the possibility of errors in the manual, for which we apologize.

The data, images and descriptions included in this manual cannot be legally asserted. We reserve the right to make changes and corrections with no prior notice.

