



Operating Manual
Handheld pH / ORP-Meter

as of version V1.2



GMH 3531

-  Please carefully read these instructions before use!
-  Please consider the safety instructions!
-  Please keep for future reference!



WEEE-Reg.-Nr. DE 93889386

GHM Messtechnik GmbH, Standort Greisinger
D - 93128 Regenstauf, Hans-Sachs-Straße 26

 +49 (0) 9402 / 9383-0  +49 (0) 9402 / 9383-33  info@greisinger.de

Inhalt

1	GENERAL NOTE	3
2	SAFETY	3
2.1	INTENDED USE	3
2.2	SAFETY SIGNS AND SYMBOLS	3
2.3	SAFETY GUIDELINES	3
3	PRODUCT SPECIFICATION	4
3.1	SCOPE OF SUPPLY	4
3.2	OPERATION AND MAINTENANCE ADVICE	4
4	HANDLING	5
4.1	DISPLAY	5
4.2	PUSHBUTTONS	5
4.3	CONNECTIONS	6
4.4	POP-UP CLIP	6
5	START OPERATION	7
6	PRINCIPLES OF THE MEASUREMENTS	7
6.1	PH MEASUREMENT	7
6.2	ORP MEASUREMENT	7
6.3	RH MEASUREMENT	8
6.3.1	<i>Manual input of pH value (and temperature)</i>	8
6.3.2	<i>Automatic input of pH value from preceding pH measurement</i>	8
6.4	PH ELECTRODE	8
6.4.1	<i>Design</i>	8
6.4.2	<i>Further Information</i>	8
6.4.3	<i>pH electrode suggestions</i>	9
6.5	CALIBRATION OF PH MEASUREMENT	9
6.5.1	<i>How to prepare calibration buffers of standard GPH series (capsules)</i>	9
6.5.2	<i>Automatic temperature compensation during calibration</i>	9
6.5.3	<i>How to carry out calibration</i>	10
7	CONFIGURATION	11
8	OUTPUT	13
8.1	SERIAL INTERFACE	13
8.2	ANALOG OUTPUT	13
9	INPUT ADJUSTMENT	13
10	GLP	14
10.1	CALIBRATION INTERVAL (C.INT).....	14
10.2	CALIBRATION STORAGE (READ CAL).....	14
11	REAL TIME CLOCK („CLOC“)	14
12	ACCURACY CHECK / ADJUSTMENT SERVICE	14
13	ERROR AND SYSTEM MESSAGES	15
14	RESHIPMENT AND DISPOSAL	15
14.1	RESHIPMENT	15
14.2	DISPOSAL INSTRUCTIONS	15
15	SPECIFICATION	16
16	NOTES A: TEMPERATURE INFLUENCE ON PH BUFFER SOLUTIONS	18
17	NOTES B: PREPARATION OF PH BUFFER SOLUTIONS	18

1 General Note

Read this document carefully and get used to the operation of the device before you use it. Keep this document within easy reach near the device for consulting in case of doubt.

Mounting, start-up, operating, maintenance and removing from operation must be done by qualified, specially trained staff that have carefully read and understood this manual before starting any work.

The manufacturer will assume no liability or warranty in case of usage for other purpose than the intended one, ignoring this manual, operating by unqualified staff as well as unauthorized modifications to the device. The manufacturer is not liable for any costs or damages incurred at the user or third parties because of the usage or application of this device, in particular in case of improper use of the device, misuse or malfunction of the connection or of the device.

The manufacturer is not liable for misprints.

2 Safety

2.1 Intended Use

The device is designed for measuring pH and ORP potentials with the help of adequate electrodes. The electrode is connected via BNC-socket.

Please note: Different electrode types are needed for pH and ORP measurements.

It is possible to connect a temperature probe (Pt1000, banana plugs) additionally. This enables an automatic temperature compensation (ATC) for pH, rH and mV_H measurements and displaying the media's temperature.

The safety requirements (see below) have to be observed.

The device must be used only according to its intended purpose and under suitable conditions.

Use the device carefully and according to its technical data (do not throw it, strike it, ...)

Protect the device from dirt.

2.2 Safety signs and symbols

Warnings are labeled in this document with the followings signs:



Caution! This symbol warns of imminent danger, death, serious injuries and significant damage to property at non-observance.



Attention! This symbol warns of possible dangers or dangerous situations which can provoke damage to the device or environment at non-observance.



Note! This symbol point out processes which can indirectly influence operation or provoke unforeseen reactions at non-observance.

2.3 Safety guidelines

This device has been designed and tested in accordance with the safety regulations for electronic devices. However, its trouble-free operation and reliability cannot be guaranteed unless the standard safety measures and special safety advises given in this manual will be adhered to when using the device.

1. Trouble-free operation and reliability of the device can only be guaranteed if the device is not subjected to any other climatic conditions than those stated under "Specification".

If the device is transported from a cold to a warm environment condensation may cause in a failure of the function. In such a case make sure the device temperature has adjusted to the ambient temperature before trying a new start-up.

2.  **DANGER** If there is a risk whatsoever involved in running it, the device has to be switched off immediately and to be marked accordingly to avoid re-starting. Operator safety may be a risk if:
- there is visible damage to the device
 - the device is not working as specified
 - the device has been stored under unsuitable conditions for a longer time.
- In case of doubt, please return device to manufacturer for repair or maintenance.
3. When connecting the device to other devices the connection has to be designed most thoroughly as internal connections in third-party devices (e.g. connection GND with protective earth) may lead to undesired voltage potentials that can lead to malfunctions or destroying of the GMH 3531 and the connected devices.



This device must not be run with a defective or damaged power supply unit.
Danger to life due to electrical shock!

4.  **DANGER** Do not use these products as safety or emergency stop devices or in any other application where failure of the product could result in personal injury or material damage. Failure to comply with these instructions could result in death or serious injury and material damage.

5.  **DANGER** This device must not be used at potentially explosive areas! The usage of this device at potentially explosive areas increases danger of deflagration, explosion or fire due to sparking.

3 Product Specification

3.1 Scope of supply

The scope of supply includes:

- GMH 3531 with 9V-batterie
- Operating Manual

3.2 Operation and maintenance advice

1. Batteriebetrieb:

If Δ and 'bAt' are shown in the lower display the battery has been used up and needs to be replaced. However, the device will operate correctly for a certain time. If 'bAt' is shown in the upper display the voltage is too low to operate the device; the battery has been completely used up.



The battery has to be taken out, when storing device above 50 °C.
We recommend taking out battery if device is not used for a longer period of time.
After recommissioning the real-time clock has to be set again.

2. Mains operation with power supply

When using a power supply please note that operating voltage has to be 10.5 to 12 V DC.



Do not apply overvoltage!! Cheap 12V-power supplies often have excessive no-load voltage.
We, therefore, recommend using regulated voltage power supplies.

Trouble-free operation is guaranteed by our power supply GNG10/3000.

Prior to connecting the power supply to the mains make sure that the operating voltage stated at the power supply is identical to the mains voltage.

3. Treat device and sensor carefully. Use only in accordance with above specification. (do not throw, hit against etc.). Protect plug and socket from soiling.
4. Display values for damaged electrode cable or if no pH or ORP electrode has been connected:
If no electrode is connected or the connection cable is damaged the display will nevertheless show mV, pH or rH values. Please note that these values can never be correct measuring results!

4 Handling

4.1 Display

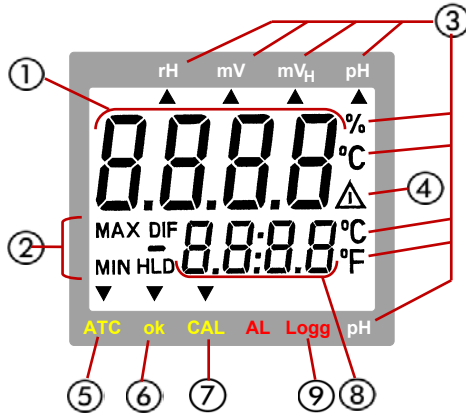

1	Main display: pH value, ORP value (mV, mV _H), rH value
2	Display elements to show minimum/maximum/memorized measuring value
3	Arrows to selected measuring unit
4	Warning signal (low battery or recalibration prompt)
5	atc arrow: indicates if temperature sensor is connected and therefore automatic temperature compensation is active (only for 'pH', 'mV _H ' and 'rH' measuring mode)
6	stab arrow: indicates stable measuring value
7	cal arrow: indicates a running calibration (at operation mode 'pH').
8	Secondary display: temperature value
9	No function

4.2 Pushbuttons



	On / off key
	min/max when taking measurements:
+	press shortly: min. or max. meas. value so far will be displayed
	press for 2 sec.: the min. or max. value will be deleted
	Configuration: to enter values, or change settings
	Cal: only at mode 'pH':
	press shortly: display of electrode state rating (electrode symbol +bar graph display)
	press for 2 sec: start pH calibration
	Set/Menu:
	press shortly: at 'pH', 'rH' and 'mV _H ': manual temperature input (if no temperature probe is connected)
	additionally at 'rH': manual input of pH value
	press for 2 sec. (menu): invoke configuration menu
	Store/Quit:
	Measuring: hold and save current measuring value ('HLD' is displayed)
	Set/Menu: confirm settings, return to measuring

4.3 Connections

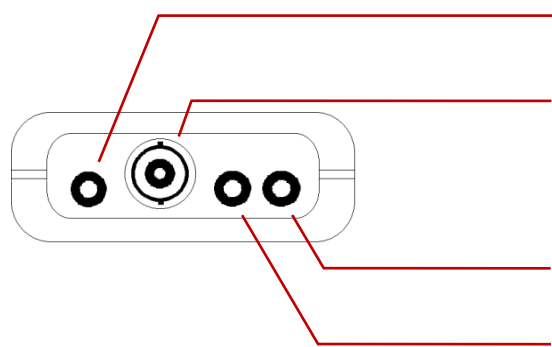

interface: connection for galv. Isolated interface adapter (accessory: GRS 3100, GRS3105 or USB3100)

BNC socket: connection of pH or ORP electrode (glass electrodes or combination electrodes)

Banana sockets:
Connection of Pt1000 temperature probe

Electrodes with integrated temperature sensor:
the banana plug is connected from outside

Separately lead through reference electrode:
it is connected from inside

Power supply: additional d.c.connector (internal pin \varnothing 1.9 mm) for external 10.5-12V direct voltage supply.

4.4 Pop-up clip

Handling:

- Pull at label "open" in order to swing open the pop-up clip.
- Pull at label "open" again to swing open the pop-up clip further.

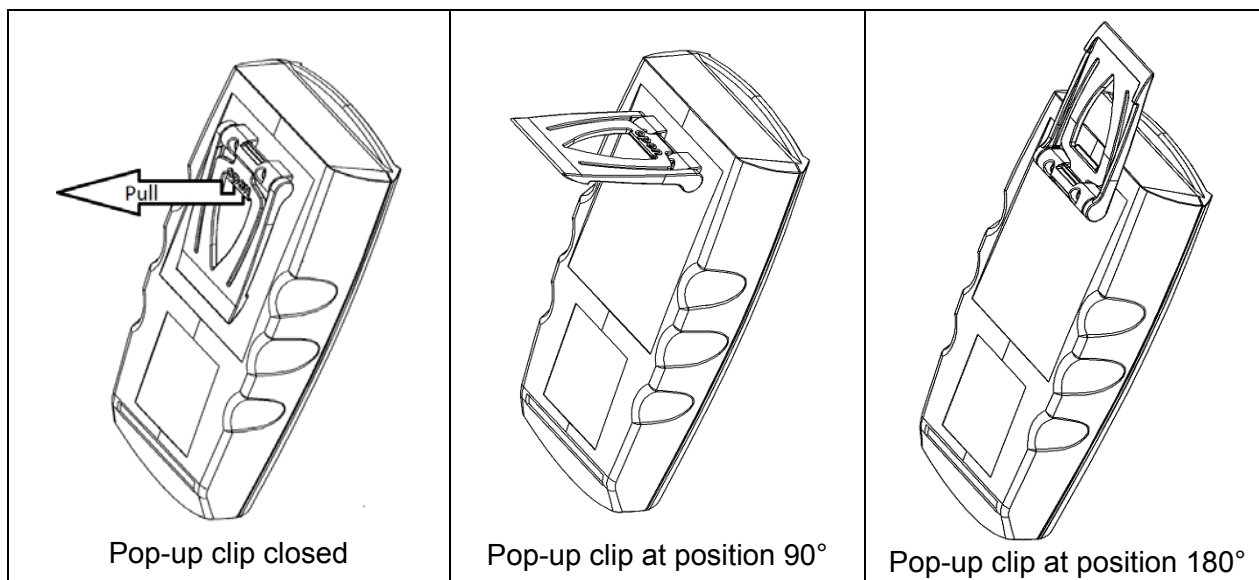

Function:

- The device with a closed pop-up clip can be plainly laid onto a table or attached to a belt, etc.
- The device with pop-up clip at position 90° can be set up on a table, etc.
- The device with pop-up clip at position 180° can be suspended from a screw or the magnetic holder GMH 1300.

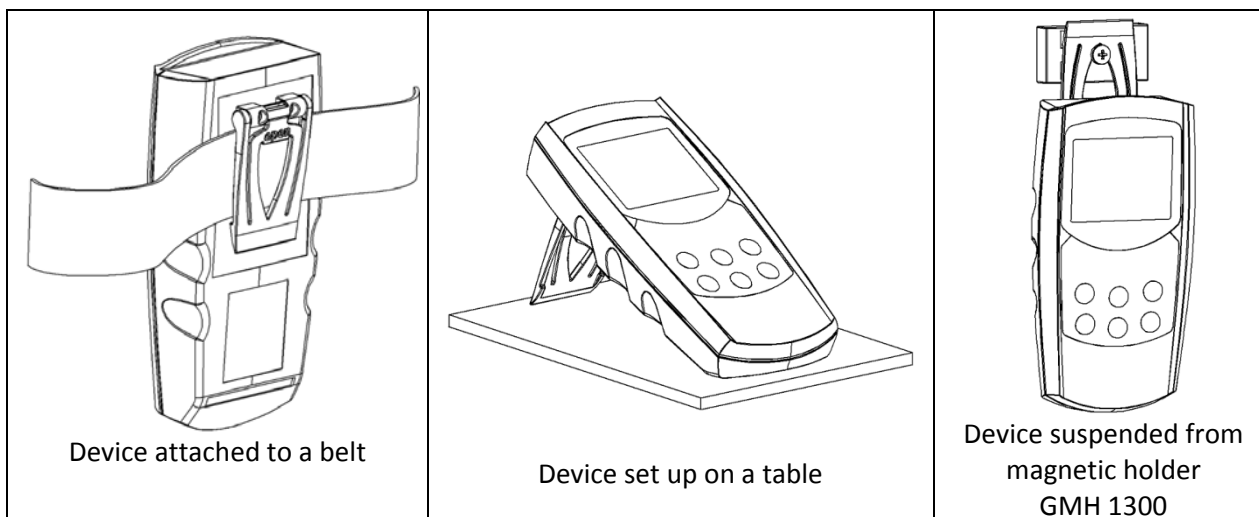

5 Start Operation

Connect electrodes, turn device on via  key.



After segment test the device displays some configuration:

[*corr*] if zero point or slope correction is active

(p.r.t chapter 7 „Configuration“ and 9 „Input adjustment“)

Remove protective cap from electrode. (Attention: Cap should contain KCL 3 M or storage solution)

After that the device is ready for measuring.

6 Principles of the measurements

6.1 pH measurement

The pH value specifies the acid or alkaline behavior of aqueous solutions.

Solutions with a pH values below 7 are acid (the more below 7 the more acid), values higher than 7 mean alkaline and pH = 7 means neutral.

The pH value is the negative common logarithm of the hydrogen ion activity (this is often approximately equal to the concentration of dissolved hydronium ions):

$$pH \text{ value} = -\log_{10} \left(\frac{c(\text{H}^+) \cdot f(\text{H}^+)}{1 \text{ mol/l}} \right) \quad \text{with} \quad c(\text{H}^+): \text{concentration of dissolved hydronium ions in mol/l}$$

$$f(\text{H}^+): \text{activity coefficient (normally lower than 1)}$$

The abbreviation “pH” stands for *pondus Hydrogenii* (Latin pondus: “weight”; Hydrogenium: “hydrogen”).

pH values should always be measured and saved together with the temperature of the solution:

i.e. pH 5.87; 22.8 °C.

Reason: The pH values of most liquids are depending on temperature.

The pH measurement is highly precise but also very sensitive. The measured signals are very weak (high resistance), especially if measured in low-ion media. Therefore it is very important that:

- disturbances (electrostatic charge, etc.) are prevented.
- a stable value is reached by slow stirring.
- contact plugs are kept clean and dry.
- the electrode shaft is not submersed for a longer period (exception: special water-proof types).
- the electrode is calibrated often enough (see below). The needed calibration frequency depends on the used electrode and application and varies between once every hour to once in several weeks.
- A suitable electrode is chosen. Please refer to chapter 6.4

6.2 ORP measurement

The ORP potential (also known as reduction potential or ORP) is a measure of the oxidizing or reducing potential of the measured media compared to the standard hydrogen electrode.

This potential is often used in swimming pools to rate the disinfectant effect of chlorination. Also for aquarium keepers the ORP value is an important parameter, because fishes need ORP values within specified boundaries to live. Drinking water purification, water monitoring and industrial applications are some further fields where the ORP value is of importance.

The measurement is done with a common silver chloride electrode (reference system with 3-molar potassium chloride solution). The measured value can be directly displayed (mode mV) or converted to “reference system: standard hydrogen electrode” and temperature compensated at mode mV_H.

There is no calibration comparable with that of the pH measurement. However, the electrode's capability can be checked with ORP test solutions (for example GRP 100).

Suitable ORP electrodes: e.g. **GE 105 BNC**

6.3 rH measurement

The rH value is a calculated value of a pH **and** an ORP measurement. For example it is used to describe the anti oxidative effect of food. This is a measure for the ability of food to reduce harmful free radicals.

To measure the rH value of a solution, proceed as follows:

6.3.1 Manual input of pH value (and temperature)

You can set the value for pH and temperature (if no temperature sensor is connected) manually. Press key

 shortly and set the temperature value with keys  and . Press  shortly again and enter the pH value. Confirm with .

6.3.2 Automatic input of pH value from preceding pH measurement

 It is important that the pH and ORP electrodes are in sound condition and that they are cleaned and dried well before they are inserted to the solution.

First place pH and ORP electrode and temperature probe in the solution and stir carefully.

1. Measuring pH value:

Connect the pH electrode and temperature probe to the GMH 5550.

Then set device to pH measuring mode and calibrate electrode if necessary (p.r.t. chapter 6.5 Calibration of pH measurement and chapter 7 Configuration).

Measure the pH value of the solution and store the measured value with . Do not turn off the device until the tH measurement is finished. If the device is turned off the saved pH value is deleted and has to be set manually for the following rH measurement.

2. Get the rH value:

Connect ORP electrode and set device to rH measuring mode. The main display shows the calculated rH value of the solution, the secondary display shows the prior measured pH value and the temperature alternatingly.

6.4 pH electrode

6.4.1 Design

In most cases so-called combination electrodes are used. That means that all needed elements are integrated in a single electrode (including reference electrode).

Sometimes even a temperature sensor is integrated.

The picture on the right shows an electrode without temperature sensor.

There are several design types for the diaphragm, but generally said it is the connection between electrolyte and the measured solution. A blockade or soiling of the diaphragm is often the reason for the electrodes idleness and erratic behavior.

The glass membrane has to be treated with care. The hydrated gel layer forms on the surface of the glass membrane, which is of highest importance for the measurement. The electrode has to be kept wet to preserve the hydrated gel layer (see below).

6.4.2 Further Information

pH-electrodes are wear parts which need to be replaced, if the values required can no longer be kept even after thorough cleaning and recovery or the electrode signal gets to slow. The actual lifetime of an electrode depends highly on the chemical or mechanical stress it is subjected to. Please take into account that there are several materials that are in aqueous solutions aggressive to glass; other chemicals may react with the KCl-solution in the electrode thus causing blockades in the diaphragm.

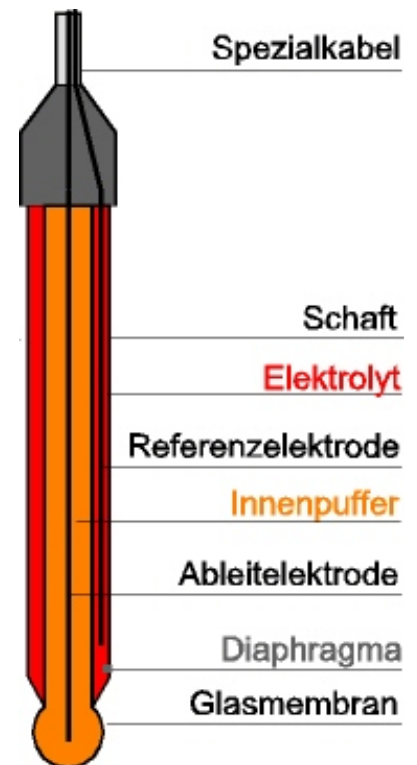

Examples:

- with solutions containing protein, like they are used on the medical and biological sector, KCl may result in the denaturation of the protein.
- coagulated varnish
- solutions with a relatively high concentration of silver ions

Any material depositing on the measuring membrane or the diaphragm will influence the measurements and have to be removed at regular intervals. This can be done by means of automatic cleaning equipment.



Electrodes have to be stored in a way that they are kept wet. An adequate solution is to store them with suitable protective cap filled with KCl 3 M. Please consider also the instructions in the electrodes manual!

6.4.3 pH electrode suggestions

Different applications require different electrodes

1. **Measurements in low-ion media** (rain water, aquarium water, VE-waters)
GE 104 BNC (as of 20 $\mu\text{S}/\text{cm}$)
2. **Sea water aquariums**
Standard pH electrodes with 3mol KCl (**GE 100 BNC, GE 117**)
3. **Swimming pools**
Standard pH electrodes with 3mol KCl (**GE 100 BNC, GE 117**)
4. **Soil checks**
Glass electrodes with several diaphragms (**GE 101 BNC**); use insertion mandrel!
5. **Electroplating, some paints and lacquers**
Glass electrode **GE 151 BNC**
6. **Cheese, fruit, meat**
Insertion electrode (**GE 101 BNC or GE 120 BNC**).
When taking measurements in cheese, milk and other high-protein products use special cleaning agent to clean electrode. (**pepsin solution - GRL 100**).

Standard cleaning: apply 0.1 molar HCl-solution for at least 5 minutes or protein cleaning agent.

The average service life of an electrode is 8 to 10 months but may be increased to 2 years if electrode is well maintained and treated carefully. We regret not being able to give a more detailed information as this is highly dependent on the individual case of application.

6.5 Calibration of pH measurement

The electrode data of pH electrodes are subject to fluctuation due to ageing and manufacturing tolerances. Therefore it is necessary to check the calibration with buffer solutions before measurements take place. If deviations are too large, a recalibration is necessary. See also chapter 10 GLP.

Buffer solutions are liquids with an accurate pH-value. The following buffers can be used for calibration:

- Technical buffer series **PHL** (ready to use, pH 4.01, pH 7.00 und pH 10.01)
- Standard series **GPH** (buffer capsules to be mixed with water pH 4.01, pH 7.00 and pH 10.01)
- DIN series **CAL dIn** (pH 1.68 (A), pH 4.01 (C), pH 6.87 (D), pH 9.18(F) und pH 12.45(G))
- Arbitrary buffer **CAL Edit** (neutral buffer ranging from 6.5 ... 7.5pH)



Service life of a buffer solution is limited and will be further reduced unless the electrodes are properly rinsed and dried when changing over the solutions. This may even result in incorrect calibration! We recommend to use new buffer solution for calibration, as far as possible, and to rinse with deionized or distilled water.

6.5.1 How to prepare calibration buffers of standard GPH series (capsules)

See notes B.

6.5.2 Automatic temperature compensation during calibration

Both the signal of the pH-electrode and the pH-buffer are depending on temperature. If a temperature probe is connected, the temperature influence of the electrode is compensated automatically during measuring as well as during calibration. Otherwise enter actual buffer temperature as accurate as possible (see below). When working with the standard or DIN-buffer series, the influences of buffer temperature are also compensated. If buffers are entered manually, make sure to enter the pH-values of the buffers at the relevant temperature to ensure optimum calibration of the device.

6.5.3 How to carry out calibration

Please note: the calibration can only be carried out at a temperature range of 0 - 60°C !

If you have not yet done so set device to measuring mode 'pH'. Make sure that either the **1-, 2- or 3- point calibration** (whichever is required) and desired buffer series (**PHL, GPH, dIn** or **Edit**) has been activated (further information in chapter 7 „Configuration“).

Carefully remove electrode safety cap (Attention! Contains 3 mol KCl!).

Rinse electrode with distilled water and dry it carefully.

How to start calibration: press  key for 2 seconds.

The display will prompt you to measure the first calibration solution.

You can abort calibration at any time by pressing  key. In such a case the last calibration before this one remains valid.

1. Calibration point 1: 'Pt. 1'

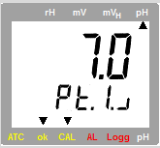

*1)



Place electrode and temperature probe (if any) in the neutral solution stirring gently.

(For 1-point calibration: solutions with arbitrary pH value (e.g. pH 4) can be used)

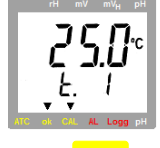
As soon as the measured pH value got stable the next calibration step will be displayed.



No temperature sensor: manual input of temperature of buffer 1

Use  or  to enter the temperature of the buffer solution.

Use  to confirm the value; the next calibration step is displayed.

If 1-point calibration is chosen the calibration is already done at this point, the bar graph display on the left shows the electrode's state rating.

2. Rinse electrode in distilled or deionized water, dry electrode

3. Calibration point 2: 'Pt. 2' (only for 2- or 3- point calibration)

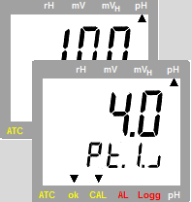



*1)

Place electrode and temperature probe (if any) in the second buffer solution (e.g. for standard series this is: pH 4.0 or pH 10.0) and stir gently.

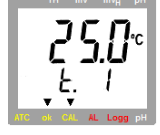
As soon as the measured pH value got stable the next calibration step will be displayed.



No temperature sensor: manual input of temperature of buffer 2

Use  or  to enter the temperature of the buffer solution.

Use  to confirm the value; the next calibration step is displayed.

If 2-point calibration is chosen the calibration is already done at this point, the bar graph display on the left shows the electrode's state rating.

4. Rinse electrode in distilled or deionized water, dry electrode

5. Calibration point 3: 'Pt. 2' (only for 3- point calibration)

Please note: both, an alkaline and acid calibration point are needed for a 3-point calibration.

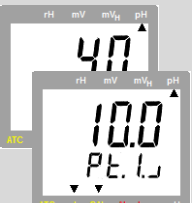



*1)

Place electrode and temperature probe (if any) in the third buffer solution (e.g. for standard series this is: pH 10.0) and stir gently.

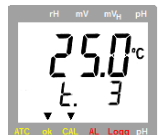
As soon as the measured pH value got stable the next calibration step will be displayed.





No temperature sensor: manual input of temperature of buffer 3

Use  or  to enter the temperature of the buffer solution.





Use  to confirm the value; the next calibration step is displayed.

Calibration has finished, the bar graph display on the left shows the electrode's state rating.

*1) In case of manual buffer selection (CAL Edit) use  or  to enter pH value of the used solution. If solutions from the standard and DIN series are used their pH value will be automatically detected.

Use  to confirm the value; the next calibration step is displayed.

Error messages of pH calibration:

	Neutral buffer not permissible - Wrong buffer solution - Buffer solution defective - Electrode defective	Always use neutral buffer as first solution (exception: 1 point calibration) Use new buffer solution Clean electrode and calibrate again, if error occurs again -> replace electrode
	Slope is too low: - Buffer solution defective - Electrode defective	Use new buffer solution Replace electrode
	Slope is too high: - Buffer solution defective - Electrode defective	Use new buffer solution Replace electrode
	Incorrect calibration temperature	Calibration can only be done at 0...60 °C

Permissible electrodes' data:





Asymmetry: ± 55 mV





Slope: -62 ... -45 mV/pH

7 Configuration



Some menu points depend on current device settings.

To change device settings, press „Menu“  for 2 seconds. This will activate the configuration menu (main display: “Set”). Pressing „Menu“  changes between the menus points, pressing  jumps to the referring parameters, which can be selected with key .

The parameters can be changed with  or . Pressing „Menu“  again jumps back to the main configuration menu and saves the settings. "Quit"  finishes the configuration and returns to standard measuring operation.



Pressing “menu” and “store” at the same time for more than 2 seconds will reset the device to factory defaults

If no key is pressed for more than 2 minutes the configuration will be aborted. All changes will not be saved!

Menü	Parameter	Werte	Bedeutung
Set Menu	CAL	2 ^{max} bzw. 5 ^{min}	
Set Configuration: General configurations			
SEt Conf	InP	Input: Selection of measured variable	
		Arrow „rH“	rH value measurement
		Arrow „mV“	mV value measurement (REDOX or ORP)
		Arrow „mV _H “	mV value measurement referring to standard hydrogen system
	Arrow „pH“	pH value measurement	
	RES ^{pH}	Resolution pH: Resolution of ph display	
		0.1 .. 0.01	tenth pH ... hundredth pH
	CAL	Calibration: Select number of calibration points	
		1-Pt	1-point (only offset calibration, slope = -59.2mV/pH)
		2-Pt	2- point (neutral + another one)
	CALP	Calibration: Select buffer series	
		GPH	Technical Buffer series: GPH-Capsules (pH7, pH4, pH 10)
PHL		Technical liquid buffer series: PHL (pH7, pH4, pH 10)	
dIn		DIN 19266 buffer series pH 1.68(A), pH 4.01(C), pH 6.87(D), pH 9.18(F), pH 12.45(G)	
Edit	Arbitrary buffer, manual input		
Cnt	Calibration: Calibration reminder period (factory setting: off)		
	1 ...365	Calibration reminder period (in days)	
	oFF	No calibration reminder	
Unit	Unit t: Select temperature unit		
	°C:	All temperatures in degree Celsius	
	°F:	All temperatures in degree Fahrenheit	
Auto	Auto Hold: Auto measuring value identification		
	on	Auto measuring value identification Auto Hold	
	oFF	Standard hold function on key press	
P.oFF	Auto Power-Off: Select power-off delay		
	1...120	Power-off delay in minutes. Device will be automatically switched off as soon as this time has elapsed if no key is pressed/no interface communication takes place.	
	oFF	Automatic power-off function deactivated (continuous operation)	
Out	Universal Output		
	oFF	Interface off -> minimal power consumption	
	SEr:	Serial interface activated	
	dAC:	Analog output activated	
Adr.	01,11..91	Base address for serial interface communication	
Set Corr: Input adjustment			
SEt Corr	OFFS ^{mV}	Zero adjustment / offset of voltage measurement	
		oFF	No zero adjustment for voltage measurement
		-10 ... 10 mV	Offset of voltage measurement in mV
	SCAL ^{mV}	Slope adjustment of voltage measurement	
		oFF	No slope adjustment for voltage measurement
		-5.00 ... 5.00%	Slope correction of voltage measurement in %
OFFS ^{°C}	Zero adjustment / offset of temperature measurement		
	oFF	No zero adjustment for temperature measurement	
	-5.0 ... 5.0°C	Offset of temperature measurement in °C	
SCAL ^{°C}	Slope adjustment of temperature measurement		
	oFF	No slope adjustment for temperature measurement	
	-5.00 ... 5.00%	Slope correction of temperature measurement in %	
Set Clock: Settings for real time clock			
SEt CLOC	CLOC	HH:MM	Clock: set time hours:minutes
	YEAR	YYYY	Year: set year
	DATE	TT.MM	Date: set date day.month
rEAd CAL.	rEAd CAL: Read calibration data: p.r.t. chapter 10.2 Calibration storage (rEAd CAL)		

8 Output

The output can be used as serial interface (for USB 3100, USB 3100 N, GRS 3100 or GRS 3105 interface adapters) or as analog output (0-1V).

If none of both is needed, we suggest to switch the output off, because battery life then is extended.

8.1 Serial Interface

By means of the serial interface and a suitable electrically isolated interface adapter (USB 3100, USB 3100 N, GRS 3100 or GRS 3105) the device can be connected to a computer for data transfer.

With the GRS 3105 up to 5 devices of the GMH3xxx- series can be connected to one interface (see also manual of GRS 3105). As a precondition the base addresses of all devices must not be identical, make sure to configure the base addresses accordingly (refer menu point "Adr." in chapter 7).

To avoid transmission errors, there are several security checks implemented e.g. CRC.

The following standard software packages are available:

- **GSOFT3050:** Operation and read out of logger function, data display in diagrams and tables
- **GMHKonfig:** Software for a comfortable editing of the device
- **EBS 20M / 60M:** 20-/60-channel software to display the measuring values

In case you want to develop your own software we offer a **GMH3000-development package** including:

- a universally applicable Windows functions library ('GMH3000.DLL') with documentation that can be used by the most programming languages. Suitable for Windows XP™, Windows Vista™, Windows 7™
- Programming examples Visual Basic 4.0™, Delphi 1.0™, Testpoint™

The device has 2 channels:

- Channel 1: actual-value-channel pH, mV or rH and base address
- Channel 2: temperature value



The unit of all transmitter values (including measuring / boundary values) is the unit of corresponding displayed values.

(e.g. temperature is displayed in °C -> temperature value is also transmitted in °C)

8.2 Analog output

An analog voltage 0-1 V can be connected at the universal output connector (mode: "Out dAC").

The analog output cannot be scaled.

Unit	0V output signal	1V output signal
pH	0.00 pH	14.00 pH
mV / mV _H	-2000 mV	2000 mV
rH	0.0 rH	70.0 rH

Please take care not to load the analog output too heavily, otherwise the output value will be distorted and the power consumption will rise. Loads up to approx. 10 kOhm are unproblematic.

If the displayed value goes beyond the fixed value, the output voltage will be 1 V.

If the displayed value falls below the fixed value, the output voltage will be 0 V.

In error case (Err.1, Err.2, etc.) the output voltage will be slightly higher than 1 V.

plug wiring:

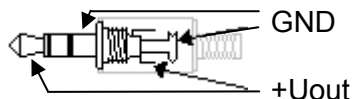

Attention!

The 3rd contact has to be left floating!
Only stereo plugs are allowed!

9 Input adjustment

The zero point and slope of each measuring inputs can be adjusted with the parameters offset ("OFFS") and scale ("SCAL").

A reasonable adjustment presumes reliable references (e.g. ice water, controlled precision water bath, etc.).

If the inputs are adjusted (i.e. offset and scale are different from default settings) the device will shortly display "Corr" after turned on.

Default setting for offset and scale are 'off' = 0.0, i.e. inputs are not changed.

Zero point correction:

$$\text{Displayed value} = \text{measured value} - \text{OFFS}$$

Zero point and slope correction:

$$\text{Displayed value} = (\text{measured value} - \text{OFFS}) * (1 + \text{SCAL} / 100)$$

$$(\text{Displayed value } ^\circ\text{F} = (\text{measured value } ^\circ\text{F} - 32^\circ\text{F} - \text{OFFS}) * (1 + \text{SCAL} / 100))$$

10 GLP

GLP (Good Laboratory Practice) includes regular check of devices and accessories. For pH measurements it is highly important to ensure correct pH calibration. The device provides the following functions to help with this.

The usage of the GLP functions is only reasonable if the electrode is not changed. Although all data is stored in the device, it refers to the particular electrode.

10.1 Calibration interval (C.Int)

You can input the interval after which the device reminds you to recalibrate.

The interval times should be chosen according to the application and the stability of the electrode.

“CAL” flashes on the display as soon as the interval has expired.

10.2 Calibration storage (rEAd CAL)

The last 16 calibrations are stored with results and date and can be read out.

Display calibration data:

Historical calibration data can be comfortably read out via PC software GMHKonfig and GSOF3050 or displayed directly at the device:



Press for 2 seconds
The display will show:

rEAd Lo55 oder SEt Conf (configuration level)



Press several times until this is displayed:

rEAd CAL. read cal. = “read calibration data”

Press shortly: switch between

- U.ASY = asymmetry voltage in mV
- SL. 1 = slope acid in mV/pH *¹⁾
- SL. 2 = slope alkaline in mV/pH *¹⁾
- date+time display of data set



OR



Change between the different calibration data sets



Quit calibration data sets display

*¹⁾ 1-point calibration: slope acid = slope alkaline = 59.16mV/pH is assumed

2-point calibration: slope acid = slope alkaline = determined slope

3-point calibration: slope acid and slope alkaline are determined separately

11 Real Time Clock („CLOC“)

The real time clock is used for chronological assignment calibration points. Please check the settings when necessary.

12 Accuracy Check / Adjustment Service

You can send the device to the manufacturer for adjustment and inspection.

Calibration certificate - DKD certificate - official certifications:

If the measuring instrument is supposed to receive a calibration certificate, it has to be sent to the manufacturer (declare test levels, e.g. -20; 0°C; 70°C).

If the device is certificated together with a suitable sensor very high overall accuracies are possible.

Basic settings can only be checked and – if necessary – corrected by the manufacturer.

A calibration protocol is enclosed to the device ex works. This documents the precision reached by the production process.

13 Error and System Messages

Display	Description	What to do?
No display or confused characters, device does not react on keypress	Battery empty	Replace battery
	Mains operation: wrong voltage or polarity	Check power supply, replace it when necessary
	System error	Disconnect battery and power supplies, wait shortly, then reconnect
	Device defective	Return to manufacturer for repair
Err.1	Measured value above allowable range	Check: Measuring value not within sensor range? -> measuring value to high!
	Sensor defective	Return to manufacturer for repair
Err.2	Measured value below allowable range	Check: Measuring value not within sensor range? -> measuring value to low!
	Sensor defective	Return to manufacturer for repair
Err.7	System error	Return to manufacturer for repair
	Value extremely out of measuring range	Check: Value not within sensor range?
>CAL< CAL flashing in display	Either preset calibration interval has expired or last calibration is not valid	Device has to be calibrated!
CAL Err.1	Neutral buffer not permissible	
	Wrong buffer solution	Always use neutral buffer as first solution (exception: 1 point calibration)
	Buffer solution defective	Use new buffer solution
	Electrode defective	Clean electrode and calibrate again, if error occurs again -> replace electrode
CAL Err.2	Slope is too low	
	Electrode defective	Replace electrode
	Buffer solution defective	Use new buffer solution
CAL Err.3	Slope is too high	
	Electrode defective	Replace electrode
	Buffer solution defective	Use new buffer solution
CAL Err.4	Incorrect calibration temperature	Calibration can only be done at 0...60 °C

If “bAt” is flashing, the battery will be exhausted soon. Further measurements are possible for short time. If “bAt” is displayed continuously the battery is ultimately exhausted and has to be replaced. Further measurements aren't possible any more.

14 Reshipment and Disposal

14.1 Reshipment



All devices returned to the manufacturer have to be free of any residual of measuring media and/or other hazardous substances. Measuring residuals at housing or sensor may be a risk for persons or environment



Use an adequate transport package for reshipment, especially for fully functional devices. Please make sure that the device is protected in the package by enough packing materials.

14.2 Disposal instructions



Batteries must not be disposed in the regular domestic waste but at the designated collecting points.

The device must not be disposed in the unsorted municipal waste! Send the device directly to us (sufficiently stamped), if it should be disposed. We will dispose the device appropriate and environmentally sound.

15 Specification

Measuring ranges	pH	0,00 ... 14,00 pH
	ORP / mV	-1999 ... 2000 mV Relating to hydrogen system: -1792 .. +2207 mV _H (bei 25°C, DIN 38404)
	rH	0,0 ... 70,0 rH
	Temperature	-5,0 ... +150,0 °C, Pt1000 23,0 ... 302,0 °F
Accuracy	pH	±0,01 pH
	ORP / mV	±0,1% FS
	Temperature	±0,2 K (in the range of -5,0...100,0°C)
Working conditions	-20 to 50 °C; 0 bis 95 % r.F. (non condensing)	
Storage temperature	-20 to 70 °C	
Connections	pH, ORP	BNC- socket, additional connection for reference electrode: 4mm banana socket
	Temperature	Pt1000 via 4 mm banana socket
	Interface	Serial interface (3.5mm jack) can be connected to USB or RS232 interface of a PC via electrically isolated interface adapter USB3100, USB 3100 N, GRS3100 or GRS3105 (see accessories) or analog output 0-1V
	external supply	d.c. connector (diameter of internal pin 1.9 mm) for external 10.5-12V direct voltage supply. (suitable power supply: GNG10/3000)
Input resistance	pH, OPR	>10 ¹² Ohm
Display	4 digit 7-segment (main and secondary display) with additional symbols	
pH calibration	Automatic	1 -, 2- or 3-point calibration, either DIN 19266-buffer or technical buffer GPH / PHL
	Manual	1 -, 2- or 3- point calibration
GLP	calibration storage adjustable calibration intervals (1 to 365 days, CAL warning after expiration)	
Additional functions	Min / max / hold / auto-hold	
Housing	Break-proof ABS housing	
	Protection class	Front side IP65
	Dimensions Wight	without BNC connector 142 x 71 x 26 mm (L x B x H) BNC connector at the devices front end: approx. 13 mm long, about 170 g incl. battery
Power supply	9V battery, type: IEC 6F22 (included in scope of supply), external d.c. supply	
Current consumption	< 1 mA (Out = Off)	
Change battery indicator	Automatically if battery exhausted Δ and ' bAt '	
Auto-off-function:	Device will be automatically switched off if no key is pressed/no interface communication takes place for the time of the power-off delay. The power-off delay can be set to values between 1and 120 min.; it can be completely deactivated.	
EMV	The device corresponds to the essential protection ratings established in the Regulations of the Council for the Approximation of Legislation for the member countries regarding electromagnetic compatibility (2004/108/EG). Additional fault: <1%	

16 Notes A: temperature influence on pH buffer solutions

GPH buffer capsules for 100 ml buffer solution

Capsules for do-it-yourself mixing – unopened capsules can be stored a long time (approx. 3 years)

T [°C]	10	20	25	30	40
GREISINGER GPH 4.0	3.99	3.99	4.01	4.01	4.03
GREISINGER GPH 7.0	7.06	7.01	7.00	6.99	6.98
GREISINGER GPH 10.0	10.18	10.06	10.01	9.97	9.89
GREISINGER GPH 12.0	12.35	12.14	12.00	11.89	11.71

PHL buffer solutions in dosing bottles 250 ml

Buffer solutions are ready for use, with dosing volume of 20 ml - 25 ml

T [°C]	10	20	25	30	40
GREISINGER PHL 4,0 (pH 4.01 +/- 0.015 @25°C)	4.02	4.00	4.01	4.01	4.01
GREISINGER PHL 7,0 (pH 7.00 +/- 0.015 @25°C)	7.06	7.02	7.00	6.99	6.97
GREISINGER PHL 10,0 (pH 10.01 +/- 0.030 @25°C)	10.18	10.07	10.01	9.97	9.89

17 Notes B: preparation of pH buffer solutions

General information on pH buffer solutions

The actual characteristic curve of pH electrodes deviates from the ideal characteristic. Thus the electrodes have to be calibrated before initial operation and thereafter at regular intervals to get accurate measuring values.

At least a 2-point calibration is required to get the parameters 'offset' and 'slope'. Two different buffer solutions are necessary for this.

A 1-point calibration only affects the 'offset' whereas 'slope' is assumed to be the ideal value of -59.2 mV/pH. A device calibrated only at 1 point assures only accurate measuring values at a range close to the buffer value.

Buffer capacity β

The pH value of a buffer solution changes only very little when small amounts of acids or bases are added. The buffer capacity β and the dilution influence dpH are values to measure this capability. The buffer capacity β is the amount of a strong acid or base that has to be added to 1 liter of the buffer solution in order to change its pH value by 1. The dilution influence dpH is the change of the pH value of the buffer solution when it is diluted with pure water at a ratio of 1 to 1.

Typical values for buffer capacity and dilution influence are: $\beta = 0.03$; $\text{dpH} = 0.05$

Please consider when choosing buffer solutions: date of expiry

Unopened and well stored buffer capsules (GPH) can be stored for a very long time in contrast to ready to use or self prepared buffer solutions. Caution with alkaline buffers: they age comparatively fast if opened (i.e. at air). The buffer gets more acid, because carbon dioxide from air is dissolved.

How to prepare calibration buffers of standard GPH series (capsules)

1. Fill 2 plastic bottles with 100 ml distilled water each.
2. Open pH 7 capsule (green) carefully (turn one half of the capsule while pulling and make sure not to spill any of the powder); put content (including both capsule parts) into one of the bottles.
3. Put content of pH 4 capsule (orange) (or pH 10, blue) and both capsule parts into a second bottle..

The capsule shell will color the liquid in the respective color:

orange = pH4.01; green = pH7.00; blue = pH10.01

Make sure to prepare buffer solutions in time as they can only be used after at least 3 hours.

Shake well before use.