





## Operating manual

### Quick-Response Double / Difference Thermometer

as of version 4.0

# GMH 3251



-  Please carefully read these instructions before use!
-  Please consider the safety instructions!
-  Please keep for future reference!



WEEE-Reg.-Nr. DE 93889386

## Index

<b>1 GENERAL NOTE .....</b>	<b>3</b>
<b>2 SAFETY .....</b>	<b>3</b>
2.1 INTENDED USE .....	3
2.2 SAFETY SIGNS AND SYMBOLS .....	3
2.3 SAFETY GUIDELINES .....	4
<b>3 PRODUCT SPECIFICATION.....</b>	<b>5</b>
3.1 SCOPE OF DELIVERY .....	5
3.2 OPERATION AND MAINTENANCE ADVICE .....	5
<b>4 HANDLING .....</b>	<b>6</b>
4.1 DISPLAY .....	6
4.2 BASIC OPERATION.....	6
4.3 CONNECTIONS .....	7
4.4 POP-UP CLIP .....	7
<b>5 START OPERATION.....</b>	<b>8</b>
<b>6 CONFIGURATION.....</b>	<b>8</b>
<b>7 REMARKS TO SPECIAL FEATURES .....</b>	<b>10</b>
7.1 TARE FUNCTION .....	10
7.2 BASE ADDRESS ('ADR.')	10
7.3 POWER OFF TIME.....	10
7.4 ALARM.....	10
7.5 REAL TIME CLOCK.....	10
<b>8 OPERATION OF LOGGER.....</b>	<b>11</b>
8.1 „FUNC-STOR“: STORING SINGLE MEASUREMENTS.....	11
8.2 „FUNC-CYCL“: AUTOMATIC RECORDING WITH SELECTABLE LOGGER-CYCLE-TIME ...	12
<b>9 OUTPUT.....</b>	<b>13</b>
9.1 SERIAL INTERFACE.....	13
9.2 ANALOGUE OUTPUT – SCALING WITH DAC.0 AND DAC.1 .....	15
<b>10 ADJUSTMENT .....</b>	<b>15</b>
10.1 ZERO DISPLACEMENT SENSOR 1 ('OFS.1') OR SENSOR 2 ('OFS.2').....	15
10.2 SCALE CORRECTION SENSOR 1 ('SCL.1') OR SENSOR 2 ('SCL.2').....	15
10.3 CORRECTION FOR SURFACE MEASURING SENSOR 1 ('SCF.1') OR SENSOR 2 ('SCF.2')	15
10.4 CALIBRATION SERVICES .....	16
<b>11 FAULT AND SYSTEM MESSAGES .....</b>	<b>16</b>
<b>12 RESHIPMENT AND DISPOSAL .....</b>	<b>16</b>
12.1 RESHIPMENT.....	16
12.2 DISPOSAL .....	17
12.3 DECOMMISSIONING .....	17
<b>13 SPECIFICATION.....</b>	<b>17</b>

## 1 General Note

Read this document carefully and get used to the operation of the device before you use it. Keep this document within easy reach near the device for consulting in case of doubt.

## 2 Safety

### 2.1 Intended Use

This device is designed for the mobile use or the stationary operation in a controlled electromagnetic environment (lab).

This device is designed for temperature measurement.

You can plug in up to 2 thermocouple sensors with Miniature-DIN-plug.

If you use two sensors, you can measure two different temperatures as well as the difference between them.

The device features a lot of useful features as for example min-/max-alarm, hold, correction factor for surface measurement, interface etc.

Personnel which starts up, operates and maintains the device has to have sufficient knowledge of the measuring procedure and the meaning of the resulting measured values, this manual delivers a valuable help for this. The instructions of the manual have to be understood, regarded and followed.

To be sure, that there´s no risk arising due to misinterpretation of measured values, the operator must have further knowledge in case of doubt - the user is liable for any harm/damage resulting from misinterpretation due to insufficient knowledge.

The manufacturer will assume no liability or warranty in case of usage for other purpose than the intended one, ignoring this manual, operating by unqualified staff as well as unauthorized modifications to the device.

The safety requirements (see below) have to be observed.

The device must be used only according to its intended purpose and under suitable conditions. Use the device carefully and according to its technical data (do not throw it, strike it, ...). Protect the device from dirt.

### 2.2 Safety signs and symbols

Warnings are labelled in this document with the followings signs:



**Caution!** This symbol warns of imminent danger, death, serious injuries and significant damage to property at non-observance.



**Attention!** This symbol warns of possible dangers or dangerous situations which can provoke damage to the device or environment at non-observance.











**Note!** This symbol point out processes which can indirectly influence operation, possibly cause incorrect measurement or provoke unforeseen reactions at non-observance.

## 2.3 Safety guidelines

This device has been designed and tested in accordance with the safety regulations for electronic devices.

However, its trouble-free operation and reliability cannot be guaranteed unless the standard safety measures and special safety advises given in this manual will be adhered to when using the device.

1. Trouble-free operation and reliability of the device can only be guaranteed if the device is not subjected to any other climatic conditions than those stated under chapter 13 Specification.
2.  **DANGER** If there is a risk whatsoever involved in running it, the device has to be switched off immediately and to be marked accordingly to avoid re-starting.  
Operator safety may be a risk if:
  - there is visible damage to the device
  - the device is not working as specified
  - the device has been stored under unsuitable conditions for a longer time. In case of doubt, please return device to manufacturer for repair or maintenance.
3.  **DANGER** Do not use these products as safety or emergency stop devices or in any other application where failure of the product could result in personal injury or material damage.  
Failure to comply with these instructions could result in death or serious injury and material damage.
4.  **DANGER** This device must not be used at potentially explosive areas! The usage of this device at potentially explosive areas increases danger of deflagration, explosion or fire due to sparking.
5.  **DANGER** This device is not constructed for use in medical applications.
6.  **DANGER** This device must not be run with a defective or damaged power supply unit. Danger to life due to electrical shock!
7.  **ATTENTION** When connecting the device to other devices the connection has to be designed most thoroughly as internal connections in third-party devices (e.g. connection GND with protective earth) may lead to undesired voltage potentials that can lead to malfunctions or destroying of the device and the connected devices.
8.  **DANGER** Temperature sensor:  
There is a risk of stitch injury by using insertion probs. When measuring high temperatures there is a risk of burn, also due to residual heat of the sensor tube.
9.  Consider when measuring in food:  
The device housing is not construed for the permanent contact with food. Keep in mind to use temperature-probes witch are suitable for the use in food only.

## 3 Product Specification

### 3.1 Scope of delivery

The scope of supply includes:

- Device with battery
- Operating manual

### 3.2 Operation and maintenance advice

- **Battery operation:**

If 'bAt' is shown in the lower display the battery has been used up and needs to be replaced. However, the device will operate correctly for a certain time. If 'bAt' is shown in the upper display the voltage is too low to operate the device; the battery has been completely used up.



***The battery has to be taken out, when storing device above 50 °C. We recommend taking out battery if device is not used for a longer period of time.***

***After recommissioning the real-time clock has to be set again.***

- **Mains operation with power supply**



When using a power supply please note that operating voltage has to be 10.5 to 12 V DC.

Do not apply overvoltage!! Cheap 12V-power supplies often have excessive no-load voltage.

We, therefore, recommend using regulated voltage power supplies.

Trouble-free operation is guaranteed by our power supply GNG10/3000.

Prior to connecting the power supply to the mains, make sure that the operating voltage stated at the power supply is identical to the mains voltage.

- Treat device and sensor carefully. Use only in accordance with above specification. (do not throw, hit against etc.). Protect plug and socket from soiling.
- Connecting/changing sensors



To disconnect thermocouple sensor plug do not pull at the cable but at the plug

**Selection of types of thermocouples:** Prior to carrying out a measurement make sure to check if device is set to the thermocouple type used (type is shown on the display shortly after unit has been switched on). Unless the correct thermocouple is set, temperature measurements will be incorrect!

## 4 Handling

### 4.1 Display

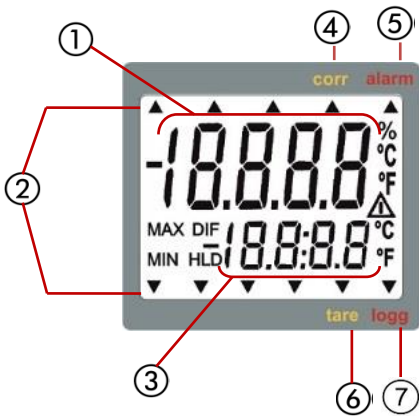

- 1 **Main display:** measuring value of **sensor 1**

---

- 2 Arrows show display options.

---

- 3 **Secondary display:** measuring value of **sensor 2** or **difference sensor 1 – sensor 2**

---

- 4 **Corr:** appears if offset-, scale correction or correction for surface measurement is <> state of delivery.

---

- 5 **Alarm:** appears with alarm condition on

---

- 6 **Tare:** appears if tare-function is active. Only with difference measurement.

---

- 7 **Logg:** appears if logger function is chosen, flashes while logger is running

### 4.2 Basic Operation



**On / Off**



**min/max measuring:**

press short: shows the min./max. value

press again: hides min./max. value

press 2 sec.: clears particular value



**Tare:** (only with 'DIF'-display and two connected sensors)



press short: the difference CH1 – CH2 will be set to 0

press 2 sec.: deactivates tare-function



**Set/Menu:**

press short: Choose secondary display: **Sensor 2** or **difference sensor 1 – sensor 2**

press long: calling of configuration



**Store/Quit:**

press short: hold-function, the last measuring value will be held.

press again: hold-function canceled

at active logger: invokes logger functions

*Please Note: Activating/deactivating tare clears the max- & min-memories.*

### 4.3 Connections

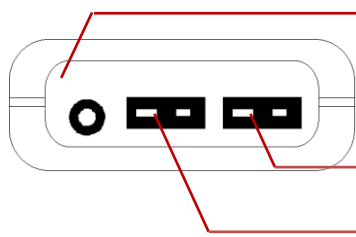

**Output:** Connection for optically isolated interface adapter or for analog output (please refer to chapter 9.2)

**Sensor Connection CH1:** channel 1

**Sensor Connection CH2:** channel 2

**Power supply:** the mains adapter socket is located at the left side of the device.

### 4.4 Pop-up Clip

**Handling:**

- Pull at label “open” in order to swing open the pop-up clip.
- Pull at label “open” again to swing open the pop-up clip further.

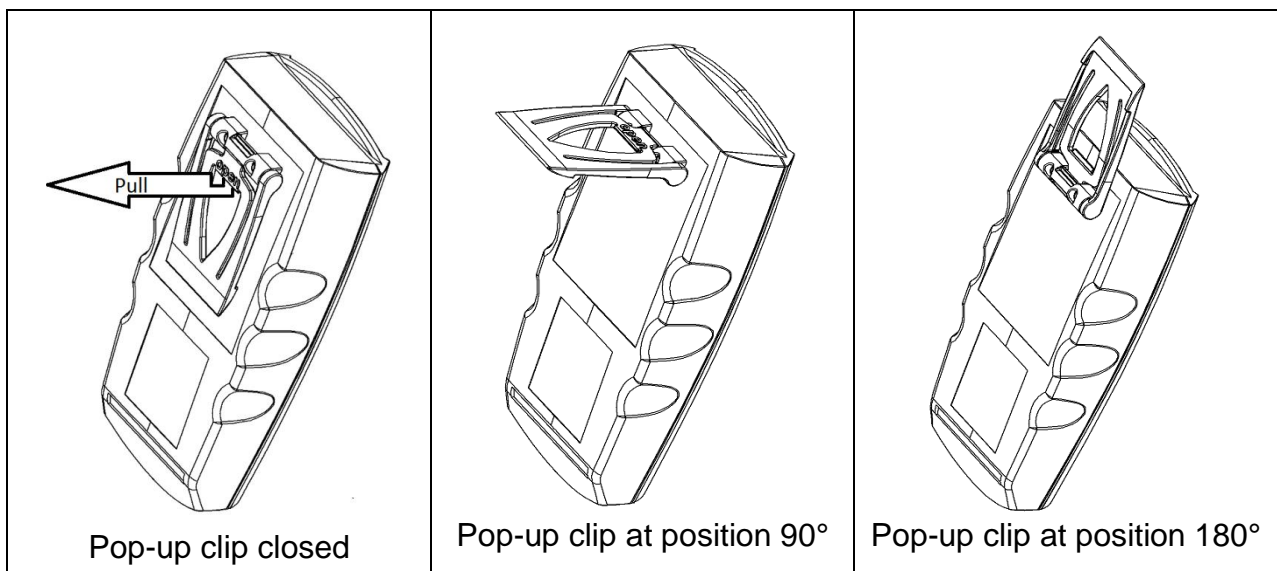

**Function:**

- The device with a closed pop-up clip can be plainly laid onto a table or attached to a belt, etc.
- The device with pop-up clip at position 90° can be set up on a table, etc.
- The device with pop-up clip at position 180° can be suspended from a screw or the magnetic holder GMH 1300.

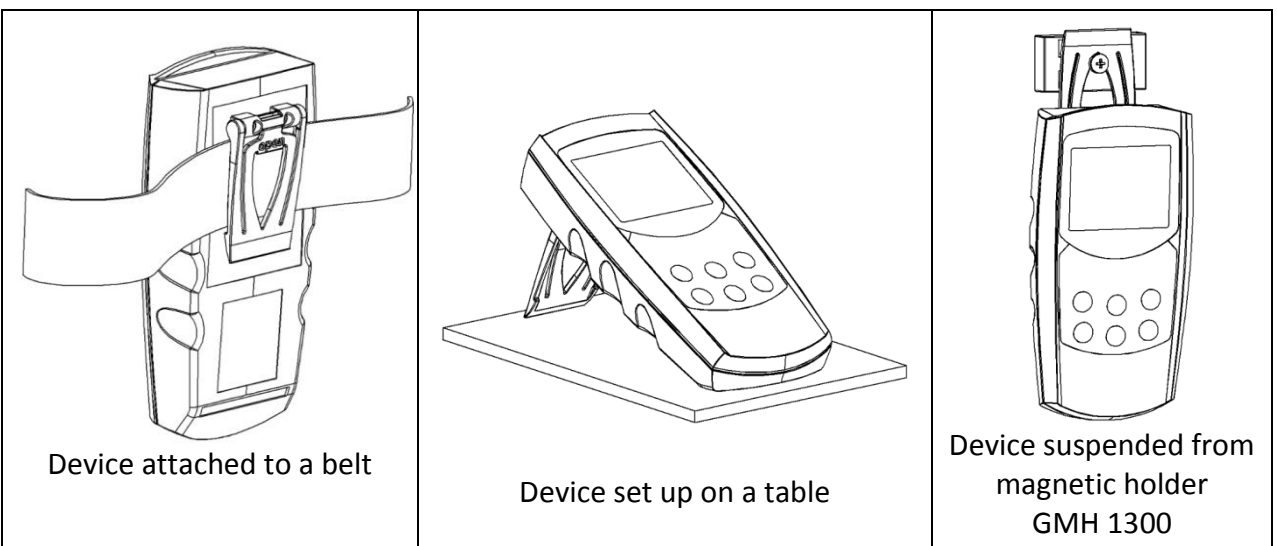

## 5 Start Operation

Connect sensor and turn on device via  key.





After segment test the device displays some configuration:

- If the surface correction factor is adjusted, the display will show „SCF.x“ and its value shortly.

After that, the device is ready for measuring.

## 6 Configuration



To change device settings, press **Set** (key 4) for 2 seconds. This will call the configuration menu (main display: „SEt“).

Pressing key **Set** changes between the menus, pressing  (key 3) jumps to the referring parameters, which can be selected with key  (key 3).

The parameters can be changed with  (key 2) or  (key 5).

Pressing **Set** again jumps back to the main configuration menu and saves the settings.

**Store** (key 6) finishes the configuration and returns to standard measuring operation.

Menu	Parameter	Values	Meaning	
KEY Menu	KEY 	KEY  or 		
rEAd LoGG	rEAd Logg: Read the single-logger data refer chapter 8.1 „Func-Stor“: Storing Single Measurements			
SEt ConF	Set Configuration: Generic Configurations			
	tYPE	ni.cr J S T N B E	<b>Selection Thermocouple:</b> Type K: NiCr-Ni Type J: Fe-CuNi Type S: Pt10Rh-Pt Type T: Cu-CuNi Type N: NiCrSi-NiSi Type B: Pt30Rh-Pt6Rh Type E: NiCr-CuNi	*
	rES	0.1° 1°	<b>Resolution:</b> 0,1°C or °F <b>Resolution:</b> 1°C or °F	*
	Unit	°C °F	Values in °C Values in °F	*
	P.oFF	1-120 oFF	<b>Auto Power Off</b> time in minutes Auto Power Off deactivated	
	Out	oFF SEr dAC	Function of the output: No output function, lowest power consumption Output is serial interface Output is analogue output 0...1V	
	Adr.	01,11..91	<b>Base address</b> of interface (if Out = SEr)	
	dAC.	CH1, CH2 or CH DIF	Choice of the input to be the source for the analogue output (if Out = dAC)	
	dAC.0	Min meas. range .. Max meas. range	Enter desired value at which the analogue output potential should be 0V (if Out = dAC)	
	dAC.1	Min meas. range .. Max meas. range	Enter desired value at which the analogue output potential should be 1V (if Out = dAC)	



SEt	Set Calibration: Adjustment of Sensors		
Corr	OFS . 1	-10.0°C..10.0°C or -18.0°F..10.0°F	The <b>offset of sensor 1</b> will be displaced by this value to compensate for deviations in the Sensor or in the measuring device.
		oFF:	Zero point displacement is deactivated (=0.0°)
	OFS . 2	-10.0°C..10.0°C or -18.0°F..10.0°F	The <b>offset of sensor 2</b> will be displaced by this value to compensate for deviations in the Sensor or in the measuring device.
		oFF:	Zero point displacement is deactivated (=0.0°)
	SCL . 1	-5.00..5.00 %	The measuring <b>scale of sensor 1</b> will be changed by this factor [%] to compensate deviations of temperature probe or measuring device.
		oFF:	Correction factor is deactivated (=0.000)
	SCL . 2	-5.00..5.00 %	The measuring <b>scale of sensor 2</b> will be changed by this factor [%] to compensate deviations of temperature probe or measuring device.
		oFF:	Correction factor is deactivated (=0.000)
SCF . 1	0.950..1.200	Correction value for surface measurement of sensor 1. (related to <b>ambient temperature</b> of the measuring device) See chapter 10.3	
	oFF:	Surface correction factor is deactivated (=1.000)	
SCF . 2	0.950..1.200	Correction value for surface measurement of sensor 1. (related to <b>ambient temperature</b> of the measuring device) See chapter 10.3	
	oFF:	Surface correction factor is deactivated (=1.000)	
SEt	Set Alarm: Settings Of Alarm Function		
AL .	AL	On	<b>Alarm</b> on, with buzzer sound
		no.So	Alarm on, without buzzer sound
		oFF	no alarm function
	AL .	CH 1	Alarm input Sensor 1 (not when AL. = oFF)
		CH 2	Alarm input Sensor 2 (not when AL. = oFF)
		CH 1.2	Common alarm Sensor 1 and Sensor 2 (not when AL. = oFF)
		DIF	Alarm input sensor difference (not when AL. = oFF)
	AL . Lo	Min meas. range .. AL.Hi	Min alarm rail of the input set under "AL." (not when AL.2 = oFF)
	AL . Hi	AL-Lo... Max meas. range	Max alarm rail of the input set under "AL." (not when AL.2 = oFF)
	SEt	Set Logger: Configuration Of Logger Function	
LoGG	Func	CYCL	<b>Cyclic:</b> logger function ,cyclic logger'
		Stor	<b>Store:</b> logger function ,individual value logger'
		oFF	no logger function
	CYCL	1..3600	Cycle time of cyclic logger [seconds]
SEt	Set Clock: Setting Of Real Time Clock		
CLOC	CLOC	HH:MM	<b>Clock:</b> Setting of time hours:minutes
	dAtE	TT.MM	<b>Date:</b> day.month
	YEAr	YYYY	<b>Year</b>

Note: When using the logger function some settings in the menu may not be accessible. Please note (\*) and (\*\*).

- (\*) This menu can only be invoked if the logger is not running! If parameters should be changed, the logger has to be **stopped** before! (key 6, p.r.t. chapter 8)
- (\*\*) This menu can only be invoked if the logger memory contains no data! If parameter should be changed the logger memory has to be **cleared** before! (key 6, p.r.t. chapter 8)

## 7 Remarks To Special Features

### 7.1 Tare Function

The tare function is used to set the DIF-display to zero, which is especially important when monitoring temperature differences. If the tare key is pressed for more than 2 seconds DIF = CH1-CH2 will be restored. This function as well as the DIF-display can only be used with two sensors connected. If the tare function is activated, this will be shown by the tare arrow in the display. Tare has no effect on logger recordings.

### 7.2 Base Address ('Adr.')

Using the interface converter GRS3105 it is possible to connect several instruments to a single interface. As a precondition the base addresses of all devices must not be identical. In case several devices will be connected via one interface make sure to configure the base addresses accordingly. Channel 1 will be addressed by the base address set, channels 2 and 3 will have the following addresses.

(Example: base address 21 - channel 1 = 21, channel 2 = 22, channel 3 = 23)

### 7.3 Power off Time

If there won't be pressed any key and no interface communication takes place for the time of the power off time setting (P.Off), the device will be switched off automatically to save battery power.

If P.oFF = oFF then the automatic switch off is deactivated.

### 7.4 Alarm

There are three possible settings: Alarm off (AL. oFF), on with horn sound (AL. on), on without horn sound (AL. no.So). Following conditions will display an alarm, when the function is activated (on or no.So):

- Value is below lower (AL. Lo) or above upper alarm rail (AL.Hi).
- Sensor error (Sens Erro)
- Low battery (bAt)
- Fe 7: System error (always with sound)

In case of an alarm and when polling the interface the prio-flag is set in the returned interface message.

### 7.5 Real Time Clock

The real time clock is used for the logger function: Recorded values are also containing the point of time, when they were measured. Please check the settings when necessary. If the battery was replaced the referring menu ,CLOC' will automatically be started

## 8 Operation Of Logger

The device supports two different logger functions:

„**Func-Stor**“ : each time when „store“ (key 6) is pressed a measurement will be recorded.

„**Func-CYCL**“ : measurements will automatically be recorded each interval, which was set in the logger menu ‚CYCL‘ until the logger will be stopped or the logger memory is full. The recording is started by pressing „Store“ 2 seconds.

The logger records 3 measurement results each time:

Value sensor 1, value sensor 2 and difference sensor 1 – sensor 2

For the evaluation of the data the software GSOFT 3050 has to be used. The software also allows easy configuration and starting of the logger.

When the logger is activated (Func Stor or Func CYCL) the hold function is no more available, the key 6 is solely used for the operation of the logger functions.

### 8.1 „Func-Stor“: Storing Single Measurements

Each time when „store“ (key 6) is pressed a measurement and its time stamp will be recorded.

The recorded data can be viewed either in the display (when calling the configuration an additional menu „REAd LoGG“ is displayed, see below) or by means of the interface and a PC with GSOFT3050-software.

**Please note:** For the Func-Stor-logging function it is not allowed to change the sensor after values are stored, otherwise invalid data could be read out.

Max. number of measurings: 1000

A measuring contains:

- sensor 1, current measuring value at the time of recording
- sensor 2, current measuring value at the time of recording
- difference sensor 1 - sensor 2, current measuring value at time of recording
- time and date of the recording

After each recording „St. XX“ will be displayed for a short time. XX represents the number of the recording.

#### If logger memory contains recordings already:

When „Store“ is pressed for 2 seconds, the choice for clearing the logger memory will be displayed:



Clear all recording



Clear the last recording



Clear nothing (cancel menu)

The selection can be made by ▲ (key 2) and ▼ (key 5). "store" (key 6) enters the choice.

If the logger memory is full, the display will show:



#### Viewing Recorded Measurements

Within the „LoGG Stor“ function the measurings can be viewed directly in the display not only by means of a computer (like at „Func CYCL“): press 2 seconds „Set“ (key 4): The first menu displayed now is „rEAd LoGG“ (read logger data). After pressing ▶

(key 3) the measurement recorded last will be displayed, changing between the different values referring to the measurement also is done by pressing  $\blacktriangleright$ . Changing the measurement is done by pressing the keys  $\blacktriangle$  or  $\blacktriangledown$ .

## 8.2 „Func-CYCL“: Automatic Recording With Selectable Logger-Cycle-Time

The Logger-Cycle-Time is settable (p.r.t. Configuration). For example „CYCL“ = 60: A measuring is recorded after each 60 seconds.

Max. number of measurements: 10000 (at max. 64 recording sequences)  
Cycle time: 1...3600 seconds (=1h), selectable in the configuration

A measuring contains:

- sensor 1, current measuring value at the time of recording
- sensor 2, current measuring value at the time of recording
- difference sensor 1 – sensor 2,  
current measuring value at time of recording

### Starting a recording:

By pressing "Store" (key 6) for 2 seconds the logger operation will be called. The display will show: 

By pressing "Store" again the recording will be initiated.

After that the display shows 'St.XXXX' for a short time whenever a measuring is recorded.

XXXX is the number of the measuring 1..10000.

If the logger memory is full, the display will show:  The recording automatically will be stopped.

### Stopping the recording manually:

By pressing "Store" (key 6) the recording can be stopped manually. Then the following choice appears:



Stop the  
recording





Do not stop the  
recording

The selection can be made by  $\blacktriangle$  (key 2) and  $\blacktriangledown$  (key 5). "Quit" (key 6) enters the choice.

**Note:** *If you try to switch off the instrument in the cyclic recording operation you will be asked once again if the recording is to be stopped!  
The device can only be switched off after the recording has been stopped!  
The Auto-Power-Off-function is deactivated during recording!*

## Clear Recordings:

By pressing "Store" (key 6) for 2 seconds the logger operation will be called.

The display will show:  By pressing the keys ▲ (key 2) or ▼ (key 5) the display will change to .

When „Store“ is pressed, the choice for clearing the logger memory will be displayed:



Clear all recordings



Clear the last recording sequence



Clear nothing (cancel menu)

The selection can be made by ▲ (key 2) and ▼ (key 5). "Quit" (key 6) enters the choice.

## 9 Output

**The output can be used as serial interface (for USB 3100, USB 3100 N, GRS 3100 or GRS 3105 interface adapters) or as analog output (0-1V).**

If none of both is needed, we suggest to switch the output off, because battery life then is extended.

### 9.1 Serial Interface

By means of the serial interface and a suitable electrically isolated interface adapter (USB 3100, USB 3100 N, GRS 3100 or GRS 3105) the device can be connected to a computer for data transfer.

With the GRS 3105 up to 5 devices of the GMH 3xxx- series can be connected to one interface (see also manual of GRS 3105). As a precondition the base addresses of all devices must not be identical, make sure to configure the base addresses accordingly (refer menu point "Adr." in chapter 6).

To avoid transmission errors, there are several security checks implemented e.g. CRC.

The following standard software packages are available:

- **GSOFT3050:** Operation and read out of logger function, data display in diagrams and tables
- **GMHKonfig:** Software for a comfortable editing of the device
- **EBS 20M / 60M:** 20-/60-channel software to display the measuring values

In case you want to develop your own software, we offer a **GMH3000-development package** including:

- A universally applicable Windows functions library ('GMH3000.DLL') with documentation that can be used by the most programming languages. Suitable for Windows XP™, Windows Vista™, Windows 7™, Windows 8 / 8.1™, Windows 10™
- Programming examples Visual Studio 2010 (C#, C++ and VB), LabView™ etc.

In addition to the operation at a PC the device can be operated with the **GAM 3000** device, to use the alarm function for simple supervision and controlling applications. Just connect a GAM 3000 to the interface, activate the alarm function of the GMH and the relays output is operating.

### The device has 3 channels:

- Channel 1: sensor 1 current measuring value (base address)
- Channel 2: sensor 2 current measuring value
- Channel 3: difference sensor 1 - sensor 2 current measuring value

*Note: The measuring-/ alarm- and display range values read back from the interface are always in the selected measurement unit!*

### Supported interface functions

Channel			Code	Function
1	2	3		
x	x	x	0	Read measurement value
x	x	x	3	Read system state
x			12	Read ID number
x			32	Read configuration flag BitAlarmOn: 1; BitAlarmSound:3; BitLoggerOn:50; BitCyclicLogger:51; BitLowPowerLogger:52
x			160	Set configuration flag (refer to 32)
x			174	Delete min. value
x			175	Delete max. value
x	x	x	176	Read min measuring range
x	x	x	177	Read max measuring range
x	x	x	178	Read measuring range unit
x	x	x	179	Read measuring range decimal point
x	x	x	180	Read kind of measuring of sensor
x			194	Set display unit
x			195	Set decimal point in display
x	x	x	199	Read kind of measuring of display
x	x	x	200	Read min display range
x	x	x	201	Read max display range
x	x	x	202	Read display range - unit
x	x	x	204	Read display range - decimal point
x			208	Read # of channels
x	x		214	Read scale correction
x	x		215	Set scale correction
x	x		216	Read offset correction
x	x		217	Set offset correction
x	x		218	Read correction factor for surface measurement
x	x		219	write correction factor for surface measurement
x			229	Logger: Read state
x			231	Logger: Read stop time
x			233	Read real time clock (CLOC)
x			234	Set real time clock (CLOC)
x			236	Read logger memory size
x			229	Logger: Read state
x			231	Logger: Read stop time
x			233	Read real time clock (CLOC)
x			234	Set real time clock (CLOC)
x			236	Read logger memory size
x			237	Read logger filecount
x			238	Read logger filepointer
x			239	Read logger file info
x			240	Reset
x			254	Program version
x			260	Logger: read data of STOR Logger
x	x	x	263	Read logger channel info

## 9.2 Analogue Output – Scaling with DAC.0 and DAC.1

**Note: Analogue output can not be used during logger recordings**

With the DAC.0 and DAC.1 values the output can be rapidly scaled to your efforts. Keep in mind not to connect low-resistive loads to the output, otherwise the output value will be wrong and battery life is decreased. Loads above ca 10kOhm are uncritical. The connection cable may not be longer than 3m.

If the display exceeds the value set by DAC.1, then the device will apply 1V to the output

If the display falls below the value set by DAC.0, then the device will apply 0V to the output

In case of an error (Err.1, Err.2, no sensor, etc.) the device will apply slightly above 1V to the output.

plug wiring:

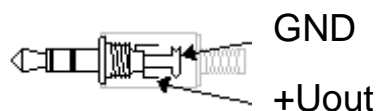

**Attention!**

the 3<sup>rd</sup> contact has to be left floating!  
Only stereo plugs are allowed!

## 10 Adjustment

### 10.1 Zero Displacement Sensor 1 ('OFS.1') or Sensor 2 ('OFS.2')

A zero displacement can be carried out for the measured value:

$$\text{value displayed} = \text{value measured} - \text{offset}$$

Standard setting: 'off' = 0.0°, i.e. no zero displacement will be carried out. Together with the scale correction (see below) this factor is mainly used to compensate for sensor deviations. Input is in the display unit.

### 10.2 Scale Correction Sensor 1 ('SCL.1') or Sensor 2 ('SCL.2')

This setting influences the scale of the measuring (factor is in %):

$$\text{displayed value} = \text{measured value} * (1 + \text{Scal}/100)$$

Standard setting: 'off' = 0.000, i.e. value is not corrected. Together with the zero displacement (see above) this factor is mainly used to compensate for sensor deviations.

### 10.3 Correction for surface measuring Sensor 1 ('SCF.1') or Sensor 2 ('SCF.2')

The correction value refers to the temperature difference between the device- / ambient temperature and the temperature determined by the thermocouple.

$$\text{Display} = \text{device temperature} + (\text{measured temperature} - \text{device temperature}) * \text{Corr}$$

Standard setting: 'off' = 1.000

This factor is used to compensate for losses of transfer in case of surface measurements, occurring if the object to be measured is extremely hot but will be cooled by lower ambient temperatures. The same can be true for sensors with a large mass. Unless 'off' is set, this value will be displayed shortly after the device is

switched on; during operation it will be identified by means of the Corr-arrow in the display



## 10.4 Calibration Services

Calibration certificates – DKD-certificates – other certificates:

If device should be certificated for its accuracy, it is the best solution to return it to the manufacturer.

Only the manufacturer is capable to do efficient recalibration if necessary to get results of highest accuracy!

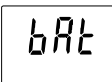
## 11 Fault and System Messages

Display	Meaning	What to do?
	Low battery power, device will only continue operation for a short period of time	Replace battery
	Battery empty Mains operation without battery: wrong voltage	Replace battery Check power supply, replace it when necessary
	No sensor connected Connected sensor or device defective Value extremely out of measuring range	Connect sensor If 2nd sensor available, check if device is ok. Return defective device/sensor to manufacturer for repair Check: right thermocouple selected.
No display or confused characters, device does not react on keypress	Battery empty	Replace battery
	Mains operation: wrong voltage or polarity	Check power supply, replace it when necessary
	System error	Disconnect battery and power supplies, wait shortly, then reconnect
	Device defective	Return to manufacturer for repair
<b>Err.1</b>	Measured value above allowable range	Check: correct thermocouple selected. Temperature not within sensor range? -> measuring value to high!
	Sensor defective	Return to manufacturer for repair
<b>Err.2</b>	Measured value below allowable range	Check: correct thermocouple selected. Temperature not within sensor range? -> measuring value to low!
	Sensor defective	Return to manufacturer for repair
<b>Err.3</b>	Display range overflow	Check: value above 1999.9 -> too high to be displayed
<b>Err.4</b>	Display range underflow	Check: value below -1999.9 (Tara?) -> too low
<b>Er.11</b>	Value could not be calculated	A value, that is necessary for the calculation, is not available (no sensor) or faulty (over- / underflow
	Calculation overflow happened	Choose different unit
<b>Err.7</b>	System error	Check allowed working temperature of the device Return to manufacturer for repair

## 12 Reshipment and disposal

### 12.1 Reshipment



All devices returned to the manufacturer have to be free of any residual of measuring media and other hazardous substances. Measuring residuals at housing or sensor may be a risk for persons or environment





Use an adequate transport package for reshipment, especially for fully functional devices. Please make sure that the device is protected in the package by enough packing materials.

Add the completed reshipment form of the GHM website

<http://www.ghm-messtechnik.de/downloads/ghm-formulare.html>.

## 12.2 Disposal



Dispense exhausted batteries at destined gathering places. The device must not be disposed in the unsorted municipal waste! Send the device directly to us (sufficiently stamped), considering the above if it should be disposed. We will dispose the device appropriately and environmentally sound.

Private user can return the device at the municipal collection points for small electrical appliances.

## 12.3 Decommissioning

When decommissioning, connections **must not** be in a condition that causes the connected evaluation electronics (e.g. interface) to trigger unexpected switching operations.

## 13 Specification

<b>Thermocouples:</b>	J, K, N, S, T, E, B	
<b>Resolution:</b>	0.1°C or 1°C	0.1°F or 1°F
<b>Measuring range:</b>		
<b>Type K (NiCr-Ni):</b>	-220.0 ... +1372.0°C	-364.0 ... +2502.0°F (*)
<b>Type J (Fe-CuNi):</b>	-200.0 ... +1100.0°C	-328.0 ... +2021.0°F (*)
<b>Type T (Cu-CuNi):</b>	-200.0 ... +400.0°	-328.0... +752.0°F
<b>Type N (NiCrSi-NiSi):</b>	-200.0 ... +1300.0°	-328.0 ... +2372.0°F (*)
<b>Type S (Pt10Rh-Pt):</b>	-50.0 ... +1768.0°C	-58.0 ... +3215.0°F (*)
<b>Type E (NiCr-CuNi):</b>	-60.0 ... +850.0°C	-76.0 ... +1562.0°F
<b>Type B (Pt30Rh-Pt6Rh):</b>	+300 ... +1750°C	+572 ... +3182°F (*)
	*) values via interface, the device displays up to 1999.9 °F	
<b>Accuracy:</b>	(for thermocouples acc. to DIN EN 60584) ±1digit (at nominal temperature ± 5K)	
<b>Type J, K, N, T, E:</b>	± (0.5°C. + 0.2% of measured value)	
<b>Type S, B:</b>	± (0.8°C. + 0.4% of measured value)	
<b>Temperature drift:</b>	0.01%/K	
<b>Point of comparison:</b>	± 0.3°C	
<b>Nominal temperature:</b>	25°C	
<b>Measuring rate:</b>	4 meas./sec	
<b>Sensor connection:</b>	2 connection sockets for miniature DIN-plug type K	

<b>Display:</b>	Two 4½ digit LCDs (12.4 mm high and 7 mm high) for measuring values, and for min/ max memories, hold function, etc. as well as additional functional arrows.
<b>Pushbuttons:</b>	6 membrane keys
<b>Logger:</b>	2 functions: individual value logger („Func–Stor“) and cyclic logger („Func–CYCL“)
Memory:	Stor: 1000 data sets CYCL: 10000 data sets (in max. 64 recording sequences) Cycle time: 1...3600 seconds
<b>Output:</b>	3.5 mm audio plug, stereo, max. permissible connection cable length: 3 m
Output function:	serial interface
Interface:	Serial interface (3.5 mm jack) can be connected to USB or RS232 interface of a PC via electrically isolated interface adapter USB3100, USB 3100 N, GRS3100 or GRS3105 (see accessories).
Analog output:	0 ... 1 Volt, freely scaleable (resolution 12 bit)
<b>Power supply:</b>	9V battery (included in scope of supply) as well as additional d.c. connector (diameter of internal pin 1.9 mm) for external 10.5-12V direct voltage supply. (suitable power supply: GNG10/3000)
Power consumption:	approx. 1.2 mA (Output „out“ = off) approx. 1.3 mA (Output „out“ = ser) approx. 1.6 mA (Output „out“ = dac)
Low battery warning:	' bAt '
Working conditions:	-25 ... +50 °C, 0 ... 95 %RH (not condensing)
Storage temperature:	-25 ... +70 °C
<b>Housing:</b>	impact-resistant ABS, membrane keyboard, transparent panel, Front side IP65
Dimensions:	142 x 71 x 26 mm (L x W x D)
Weight:	approx. 155 g
<b>EMC:</b>	The instruments confirm to following European Directives: 2014/30/EU EMC Directive 2011/65/EU RoHS Applied harmonized standards: EN 61326-1 : 2013 emissions level: class B emi immunity according to table 3 and A.1 Additional fault: <1%  EN 50581 : 2012