

GREISINGER

Member of GHM GROUP

Englisch

Operating Manual

Water analysis – hand-held
meter

G 7500 series



Companies / Brands of the GHM
Members of GHM GROUP:

GREISINGER
HONSBURG
Martens
IMTRON
Delta
VAL.CO

www.ghm-group.de

Keep for later use.

Index

1	GENERAL NOTE	3
2	SAFETY	3
2.1	INTENDED USE	3
2.2	SAFETY GUIDELINES	3
2.3	QUALIFIED PERSONNEL	3
2.4	SAFETY SIGNS AND SYMBOLS	4
2.5	FORESEEABLE MISUSE	5
2.6	SAFETY INSTRUCTIONS	5
3	PRODUCT SPECIFICATION.....	7
3.1	SCOPE OF DELIVERY	7
3.2	OPERATING AND MAINTENANCE	7
3.3	CONNECTIONS	7
3.4	SUPPORT AND RETAINING CLIP	8
4	OPERATION	9
4.1	KEYPAD	9
4.2	STATUS LINE	10
4.3	DISPLAY ELEMENTS.....	11
5	START OPERATION.....	11
5.1	SUITABLE ELECTRODES / SENSORS.....	11
6	BASICS OF THE MEASUREMENT	12
6.1	pH MEASUREMENT	12
6.2	BASICS ABOUT CONDUCTIVITY	15
6.3	CONDUCTIVITY MEASUREMENT.....	15
6.4	ELECTRODES / MEASURING CELLS	15
6.5	TEMPERATURE COMPENSATION.....	16
6.6	DESIGN OF THE SENSOR GWO 5610.....	17
6.7	COMMISSIONING / FILLING OF THE SENSOR GWO 5610.....	19
6.8	SENSOR GWO 5610 MAINTENANCE	20
6.9	BASICS ABOUT OXYGEN MEASURING.....	21
6.10	AMBIENT PRESSURE AND MEASURING DEPTH OF THE ELECTRODE	21
6.11	CORRECTION OF SALINITY	21
7	CONFIGURATION.....	22
7.1	DEVICE MENU.....	22
7.2	pH CHANNEL MENU	25
7.3	TEMPERATURE CHANNEL MENU	27
7.4	OXYGEN CHANNEL MENU	27
7.5	CONDUCTIVITY CHANNEL MENU	28
8	ERROR CODES (IN DATASET).....	29
9	CALIBRATION.....	30
9.1	GENERAL INFORMATION.....	30
9.2	pH CALIBRATION	30
9.3	O ₂ CALIBRATION	30
10	CALIBRATION AND ADJUSTMENT SERVICE.....	31
11	REPLACING RECHARGEABLE BATTERIES	31

12	RESHIPMENT AND DISPOSAL	32
12.1	RESHIPMENT	32
12.2	DISPOSAL	32
13	SPECIFICATION	33
13.1	MEASUREMENTS AND ACCURACY	33
13.2	GENERAL SPECIFICATION	34
14	TERMS OF LICENSE.....	35
14.1	FREERTOS	35
14.2	FATFS.....	35

1 General Note

Read this document carefully and get used to the operation of the device before you use it. Keep this document within easy reach near the device for consulting in case of doubt.

2 Safety

2.1 Intended Use

The device is exclusively designed for measuring of pH/ORP, conductivity, dissolved oxygen in water (saltwater and freshwater) and temperature mit jewells entsprechend geeigneten externen Sensoren/Elektroden.

Personnel which starts up, operates and maintains the device has to have sufficient knowledge of the measuring procedure and the meaning of the resulting measured values, this manual delivers a valuable help for this. The instructions of the manual have to be understood, regarded and followed.

To be sure that there's no risk arising due to misinterpretation of measured values, the operator must have further knowledge in case of doubt - the user is liable for any harm/damage resulting from misinterpretation due to insufficient knowledge.

The manufacturer will assume no liability or warranty in case of usage for other purpose than the intended one, ignoring this manual, operating by unqualified staff as well as unauthorized modifications to the device.

2.2 Safety guidelines

This device has been designed and tested in accordance with the safety regulations for electronic devices.

However, its trouble-free operation and reliability cannot be guaranteed unless the standard safety measures and special safety advises given in this manual will be adhered to when using the device.

2.3 Qualified personnel

The device may only be installed by qualified personnel who have read and understood this manual and who are able to use the devices professionally. Qualified personnel are persons who are familiar with the installation, assembly, commissioning and operation of these devices and who have the necessary qualifications to carry out their duties.

2.4 Safety signs and symbols

The following signs in this document highlight warnings:



Caution! This symbol warns of imminent danger, death, serious injuries and significant damage to property at non-observance.



This symbol indicates danger for living tissue as well as a variety of materials, which can be damaged or destroyed when coming into contact with this chemical. Caustic effect, protective equipment required!



This Symbol indicates dangers to all living beings that may result in death or acute or chronic health hazards when inhaled, swallowed, or absorbed through the skin of this chemical.



This Symbol indicates irritant substances that can cause inflammation on short-term, prolonged or repeated contact with the skin or mucous membranes.



Attention! This symbol warns of possible dangers or dangerous situations that can provoke damage to the device or environment at non-observance.



Note! This Symbol indicates operations which, if ignored, may have an indirect effect on operation, possibly leading to incorrect measurement results or triggering an unforeseen reaction.



This symbol instructs the use of eye protection which protects the eyes from harmful influences when working with powerful light, UV radiation, laser, chemicals, dust, splinters or weather influences.



This symbol instructs the use of protective gloves which offer protection from mechanical, thermal, chemical, biological or electrical hazards.

2.5 Foreseeable misuse

The fault-free function and operational safety of the product can only be guaranteed if generally applicable safety precautions and the device-specific safety instructions for this document are observed.

If these notices are disregarded, personal injury or death, as well as property damage can occur.



This device must not at all be used in potentially explosive environment! The usage of this device at potentially explosive areas increases danger of deflagration, explosion or fire due to sparking.



This device is not suitable for medical applications.



The device is not suitable for direct contact with food products. Take samples and dispose them correctly after the measurement.

2.6 Safety instructions

This device has been designed and tested in accordance with the safety regulations for electronic devices.

However, its trouble-free operation and reliability cannot be guaranteed unless the standard safety measures and special safety advises given in this manual will be adhered to when using the device.

The O₂ sensor contains potassium hydroxide. This causes burns. All contact with the skin, clothing and eyes should be avoided.

Nevertheless, should contact occur, take the following measures.



- Eyes: Flush with flowing water for at least 15 minutes, seek medical attention!
- Skin: Wash with large amounts of water for several minutes!
- Clothing: Remove immediately!
- If swallowed: Drink large amounts of water, do not induce vomiting and seek medical Attention!

If there is a risk whatsoever involved in running it, the device has to be switched off immediately and to be marked accordingly to avoid re-starting.

Operator safety may be a risk if:

- there is visible damage to the device
- the device is not working as specified
- the device has been stored under unsuitable conditions for a longer time.



In case of doubt, please return device to manufacturer for repair or maintenance.



Do not use this product as safety or emergency stop devices or in any other application where failure of the product could result in personal injury or material damage.

Failure to comply with these instructions could result in death or serious injury and material damage

When interacting with chemicals at least the following points must be ensured:

1. Obey all notes on the container of chemicals.
2. Obey all notes in the safety specification sheet of chemicals.
3. Consider any statutory provisions guidelines and guidelines of chemicals when disposing!

This is also for accidentally spilled chemicals, dried residues, soiled rags or similar.

4. Always wear suitable protective clothing (e.g. protection goggles, safety gloves, face mask, etc.)!
5. Never eat, drink or smoke in the operational area of chemicals!
6. In case of problems instantly consult skilled personnel.

Suitable clean-up possibilities (eye wash, etc.) must exist within spitting distance!



Trouble-free operation and reliability of the device can only be guaranteed if the device is not subjected to any other climatic conditions than those stated under specification

3 Product Specification

3.1 Scope of delivery

The scope of supply includes:

- Device with 3 rechargeable batteries type AAA
- Short manual
- Operating manual and calibration protocol as pdf file in mass storage.

3.2 Operating and Maintenance

1. Battery operation:

If the battery has been used up and needs to be recharged, the device will display BAT. in the upper status line. The device will, however, continue operating correctly for a certain time.

The battery has been completely discharged, if batteries empty is shown in the main display and the red backlight will blink. The device will then turn off automatically.



The device has a deep discharge protection, when the batteries reach a limit value, the device can no longer be turned on!

2. Treat device and electrodes carefully. Use only in accordance with above specification (do not throw, hit against etc.).

The measuring values can be influenced by contamination.

3.3 Connections

Front view

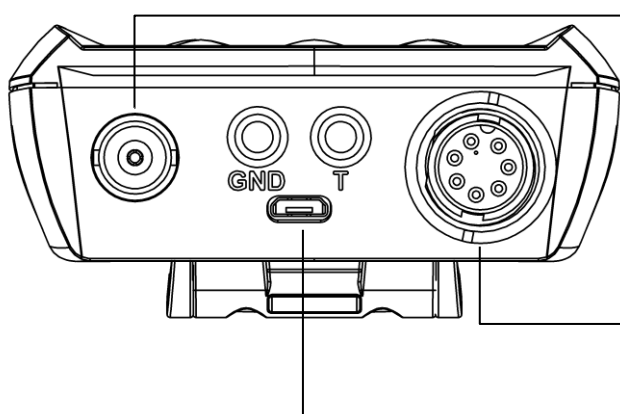

Connector	Probetype (standard)
BNC	pH (GE 125)
Banana	Resistive temperature probe
6 mm	(PT 1000 or NTC 10 k)
(GND)	common, needed only for
	separate temperature probe
Banana	Resistive temperature probe
6 mm (T)	(GE 125 banana plug)
7-pol. LTW	Oxygen (GWO 5610) or
	conductivity (LF 425)
Micro USB	For power supply or device
	communication



Waterproofness is only guaranteed for plug connections in the plugged-in state in combination with waterproof cable plugs.



The temperature measurement can be influenced by conductive liquids on the banana sockets. We recommend always keeping the connections dry.

3.4 Support and retaining clip

The stand is provided as a means to prop up or support the device in a stable surface, for hanging on the wall or for attachment to a belt.

Instruction:

- Leave the stand collapsed in order to lay the product flat on a stable surface or to hang it on a belt.
- Pull the grip labelled **open** in order to fold it out to a 90° angle. Now, the product can be positioned on a stable surface.
- Pull the grip labelled **open** again in order to fold it out to a 180° angle. Now the product can be hung.
- The product can be positioned ideally so that the display can always be read clearly and easily depending on its use.

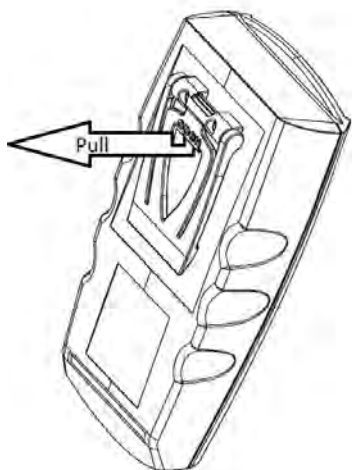

Pop-up clip closed

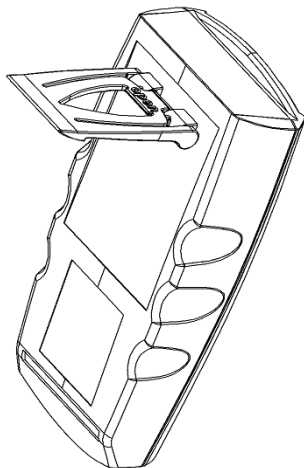

Pop-up clip at position 90°

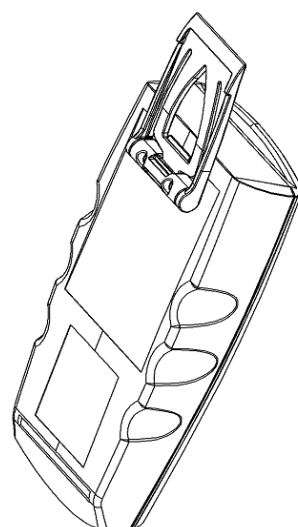

Pop-up clip at position 180°

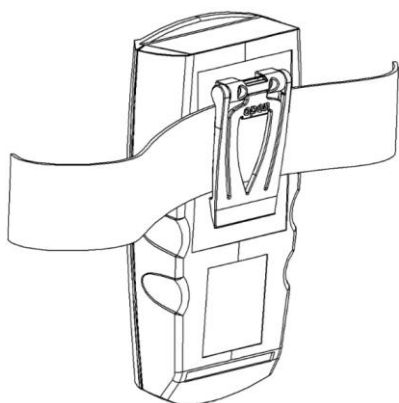

Device attached to a belt

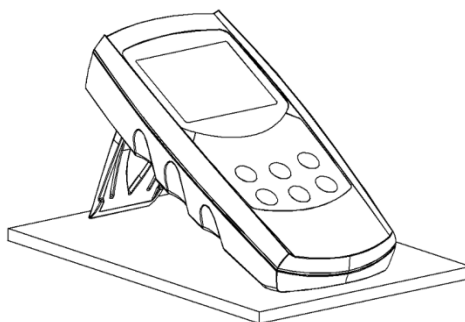

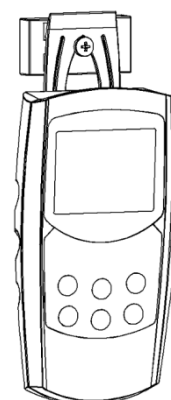

Device set up on a table



Device suspended from magnetic holder
GMH 1300

4 Operation

4.1 Keypad

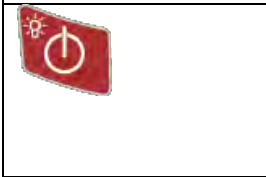
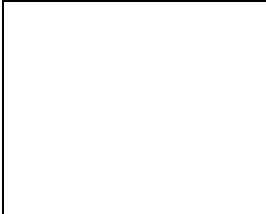
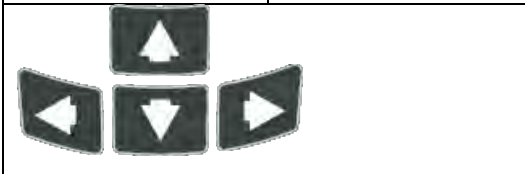
	<p>With the keypad the device functions, display mode, etc. can be set by user interaction. The display will contain specific information for the F1 and F2 soft-keys.</p>
	<p>F1 and F2 soft-key Depending to the device state (view, menu, channel, ...) the dark accentuated texts in the display directly above the soft-keys are describing the soft-keys function (e.g. 'back' for F1 and 'change' for F2).</p>
	<p>power button Will turn the device on (only when rechargeable batteries are not empty) or off (only when the logger is not running).</p>
	<p>device settings Will open the device-settings-menu. Here anything that's not related to a physical measuring e.g. the date, time USB-mode and language can be changed.</p>
	<p>directional pad (up, down, right, left) For navigation within a menu, for changing the selected channel (up and down) or changing the view (right and left).</p>

4.2 Status line

The status line is the first line in the display.

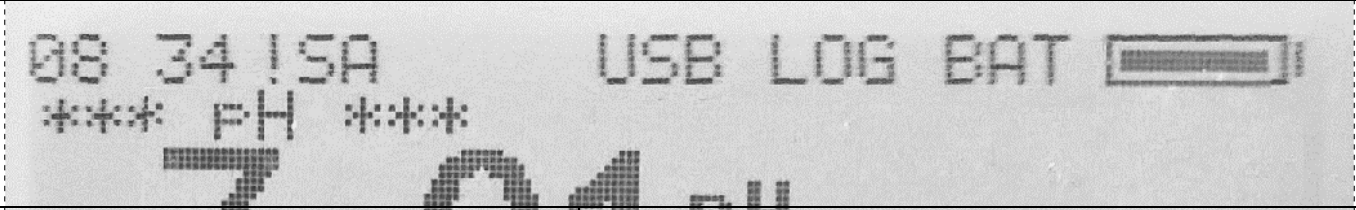
Display	Meaning
	
Current time	If time is flashing, time must be reseted
!	Internal memory error. When this error won't disappear after restarting the device, it should be returned for repairing. The device will go to a safe fallback mode were device settings are stored and recalled from the mass storage if this is available.
S	Saving to the internal mass storage takes longer than intended. When the S will be shown permanently in the display, please let Windows check the mass storage device for errors. When the S still shows up, the device needs to be send back for repairing.
A	Alarm of a channel is active
USB	USB connection has been established.
LOG	Logger is active
BAT	Rechargeable battery capacity critically low
Battery indicator	If the battery capacity flashes, the battery is being charged

4.3 Display elements

Views can be changed by the right and left keys of the directional pad. With the keys up and down the channel can be changed.

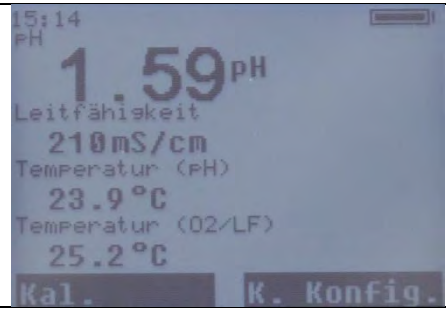
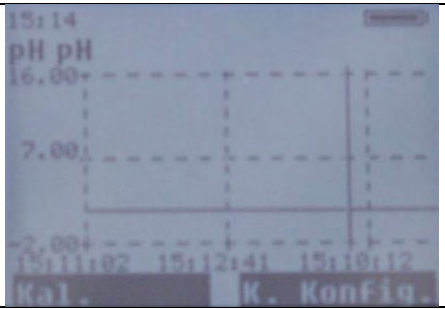
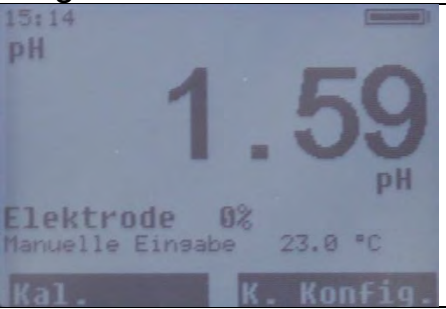
Table view	Chart view	Large view
		
All channels in one row	Chart of one channel	Display of one channel with specific parameters (here: electrode quality and temperature compensation)

4.3.1 Menu

Depending on the selected channel, you can switch to the channel configuration menu by pressing the function key F2. Here, channel-specific settings can be made.

5 Start operation

Charge the rechargeable batteries by connecting a power supply or the computer to the micro USB connector.

Connect all desired probes or electrodes.

Turn on the device by pressing the power button.

Change date, time and language by pressing the device settings key and save the changes made.

5.1 Suitable electrodes / sensors

Measurand	suitable electrodes / sensors
Conductivity	LF 425-L01, LF 425-L02, LF 400-L02
Solved oxygen	GWO 5610-L02, GWO 5610-L04, GWO 5610-L10, GWO 5610-L30
pH	suggested: GE125-BNC-L02 also all other pH-electrodes of our delivery program with BNC plug an a cable length <3m
ORP	all ORP-electrodes of our delivery program with BNC plug an a cable length <3m
Temperature	Integrated Pt1000 of the pH-electrodes GE117 or GE125, and all Pt1000-sensors of our delivery program with connection 2x banana plug 4 mm and a cable length <3m (e.g. GF 1T-T3-B-BS)

6 Basics of the measurement

At first the basics of all measurements will be depicted. Some channel specific settings depend on these basics.

6.1 pH measurement

The pH value describes the acidic or alkaline behavior of an aqueous solution. pH values below 7 are acidic (smaller values indicate higher acidity), and values above 7 are alkaline; pH 7 = neutral.

The pH measurement is very precise, but also sensitive. The measured signals are very weak (high-impedance), especially when measured in weak or low-ion media. Therefore, always take measures to



To determine the pH value of a solution, its temperature needs to be known. The reason is that most liquids change their pH value with the temperature.

- avoid interference (electrostatic charges, etc.)
- keep plug contacts clean and dry
- prevent electrodes (except special waterproof versions) from extended immersion above the shaft
- calibrate the electrode at sufficient intervals (see below). The frequency of calibration can range from every hour to several weeks, depending on the electrode and the application.
- use a suitable electrode. See chapter 6.1.4 Choosing a pH electrode on page 13.

6.1.1 Design

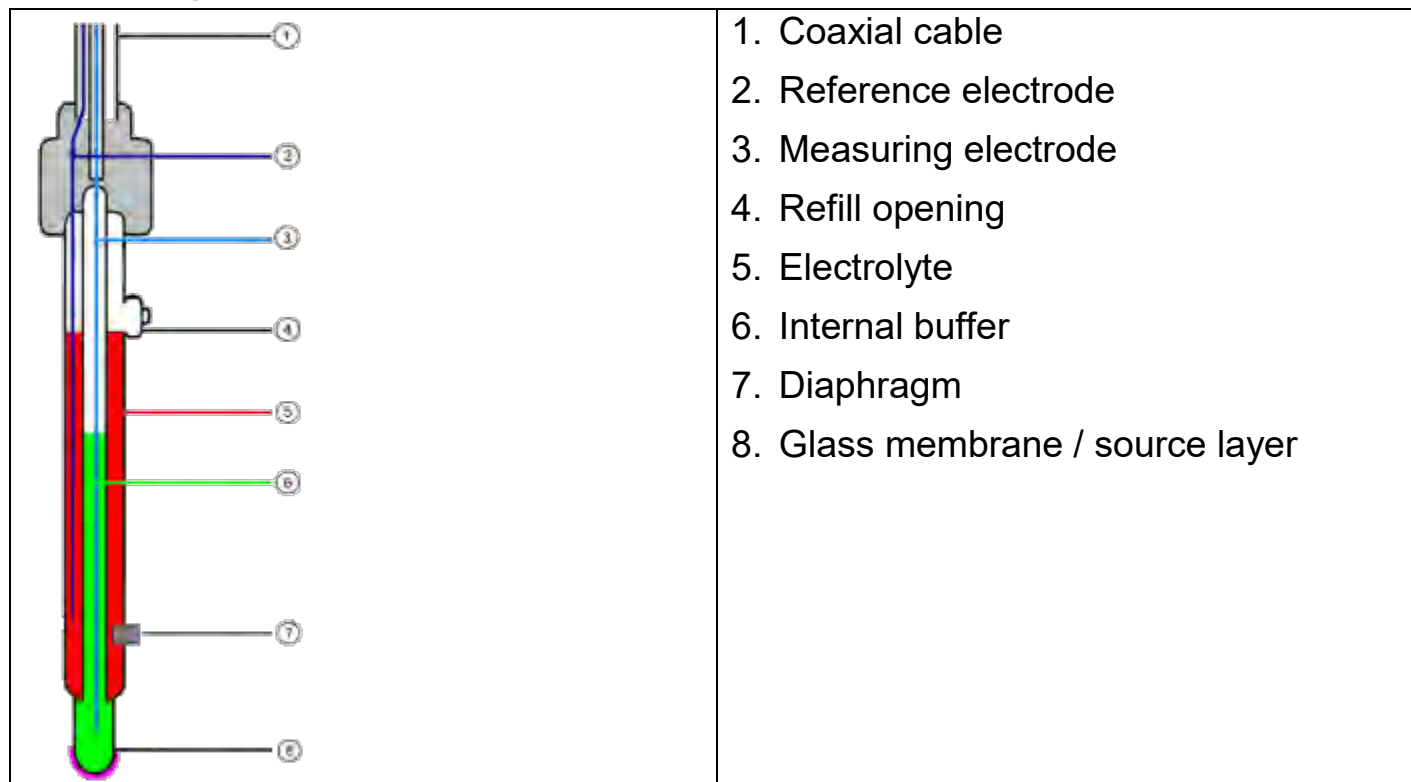

The diaphragm, which establishes a connection between the electrolyte and the liquid to be measured, can be designed in different ways. Clogging or soiling of the diaphragm is a frequent cause of a malfunctioning or sluggish electrode. Always

handle the glass membrane with extreme care. The so-called source layer forms there. This is crucial for the measurement and must always be kept moist.

There are also electrodes with integrated temperature sensors.

6.1.2 pH electrode



Normally, so-called pH single-rod measuring chains are used. They include all necessary components that are integrated in an electrode.

6.1.3 Further information

pH electrode is a wear part. If the signal is very slow or the required values are no longer observed after careful cleaning and possible regeneration, the electrode must be replaced. When using the electrodes, be aware that various substances in aqueous solutions can corrode glass and that chemicals can produce a chemical reaction with the KCl solution in the electrode, which can result in blockage of the diaphragm.

Examples:

- In solutions that contain proteins, such as for measurements in medical and biological applications, KCl can cause denaturation of the protein.
- Coagulated paints
- Solutions that contain high concentrations of silver ions

Substances that accumulate on the glass membrane or the diaphragm affect the measurement and must be removed regularly. This can be achieved for example with automatic cleaning systems.

6.1.4 Choosing a pH electrode

- GE 100 BNC is a universal electrode with two ceramic diaphragms and liquid
- GE 101 BNC is preferably used for small sample amounts. It comprises a glass electrode with two ceramic diaphragms and liquid electrolyte.
- GE 104 BNC is preferably used for measurements in low-ionic media, such as rainwater, aquarium water and deionised water.
- GE 114 WD is a universally applicable, durable and low-maintenance gel electrode with Pellon diaphragm. It can be used for measurements in drinking water, swimming pools, aquaria and slightly contaminated waste water.
- GE 117 BNC is a temperature-compensated gel electrode with two ceramic diaphragms and PH 13.5 cable screw coupling.
- GE 120 BNC is an insertion electrode and is preferably used for measurements in cheese, fruit and meat. For measurements in products containing proteins, the electrode must be cleaned with a special cleaner. For this purpose, we recommend the GRL 100 pepsin cleaning solution.
- GE 125 BNC is a waterproof, universally applicable, durable and low-maintenance gel electrode with ceramic diaphragm. It can be immersed above the shaft for an extended time.

- GE 151 BNC is a glass electrode and is preferably used in galvanic applications for paints and lacquers.
- GE 173 BNC is an alkaline-resistant glass electrode with ground diaphragm and gel electrolyte for chemical and waste water applications.

6.1.5 Service life



The service life of electrodes is normally at least 8 to 10 months. When cared for properly, this can usually increase to more than 2 years. The actual life will vary depending on the particular application.

6.1.6 Care and maintenance



The GAK 1400 working and calibration set includes all necessary products for calibration, care and maintenance of the electrode. Normal cleaning takes place with the GRL 100 pepsin cleaning solution into which the electrode is immersed for 5 minutes before being rinsed off with clean water.



Crystallization of the 3 mol/l KCL solution is unavoidable. Crystallized potassium chloride on the protective cap and shaft can easily be removed with a fingernail or cloth and is therefore does not constitute a defect or cause for complaint.

Dirty electrodes must be cleaned. The suitable cleaning agents for the pH glass membrane are listed in the table below.

Impurities	Cleaners
General residue	Mild detergent
Inorganic coatings	1 mol/l HCl solution or GRL 100 pepsin cleaning solution
Metal compounds	1 mol/l HCl solution or GRL 100 pepsin cleaning solution
Oil and grease	Special cleaner or solvent
Biological coatings with protein	1% pepsin enzyme in 0.1 molar GRL 100 HCl solution
Biological coatings with protein	Acetone
Extremely resistant residues	Hydrogen peroxide or sodium hypochloride

The material of the pH probe must always be protected. Plastic shafts must not be cleaned in solvents, etc. If in doubt, contact the manufacturer to inquire about suitable cleaners for the existing electrode. This is also important in the case of aggressive substances or other substances that are not primarily water-based!

6.2 Basics about conductivity

Definition of conductivity γ :

The ability of a material to conduct electric current: $\gamma = \frac{l}{R \cdot A}$

l : length of the material

A : diameter

R : measured resistance

Unit $[\gamma] = \frac{\text{Siemens}}{\text{Meter}} = \frac{\text{S}}{\text{m}}$, common for liquids: $\frac{\text{mS}}{\text{cm}}$ and $\frac{\mu\text{S}}{\text{cm}}$

The conductivity is the reciprocal value of the resistivity.

(The conductance is the reciprocal value of the measured resistance R)

6.3 Conductivity measurement

The conductivity measurement is a rather uncomplicated measurement. The standard measuring cells are stable for a long time if used correctly and can be adjusted by slope correction.

Range	1	2	3	4
	45..500 mS/cm	5.0..50.0 mS/cm	500..5000 $\mu\text{S/cm}$	0.0..500.0 $\mu\text{S/cm}$

Within the integrated automatic range selection, the range with the best resolution is automatically selected.

6.4 Electrodes / measuring cells

6.4.1 Design and selection

Basically there are two types of measuring cells: 2-pole and 4-pole cells. The operation is done similarly; the 4-pole measuring cells can compensate polarization effects and – up to some degree – soiling due to its complex measuring method.

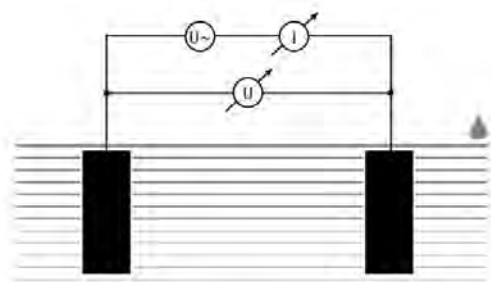

2-pole measuring cell

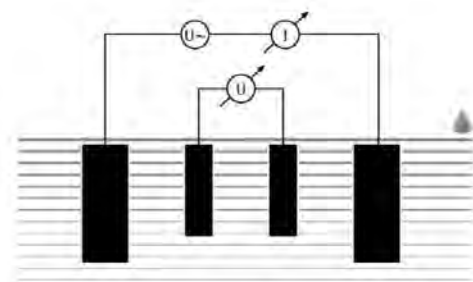

4-pole measuring cell

6.4.2 Calibration / Adjustment of measuring cells

Especially in harsh environments and over long time the cell constants of measuring cells are drifting. Depending on the application and usage we recommend a regular checking of the precision of the measuring chain: instrument + cell. For this there are control solutions available (GKL 100, 101, 102). At normal usage a checking each half year is recommended.

6.5 Temperature compensation

The conductivity of aqueous solutions depends on its temperature. The temperature dependency is strongly dependent on the type of solution. The temperature compensation recalculates solutions' conductivity to a consistent reference temperature. The most common reference temperature is 25 °C, but 20 °C can also be selected.

6.5.1 Temperature compensation “NLF” according to EN 27888

For most applications (e.g. in the area of fish farming, surface or drinking water measurements, etc.) the non-linear temperature compensation for natural water (“nLF”, according to EN 27888) is sufficiently accurate.

Recommended application range of nLF-compensation: between 60 µS/cm and 1000 µS/cm.

6.5.2 Linear temperature compensation

If the actual function needed for exact temperature compensation is not known, “linear temperature compensation” is normally selected (Menu, t.Cor = Lin, t.Lin corresponds TK_{lin}), i.e. one assumes that the actual temperature dependency at the considered concentration range is approximately equal:

$$LF_{T_{ref}} = \frac{LF_{T_x}}{1 + \frac{TK_{lin}}{100\%} \cdot (T_x - T_{ref})}$$

Temperature coefficient of about 2.0 %/K are most common.

A temperature coefficient can be determined for example by measuring a solution with deactivated temperature compensation at two different temperatures (T1 and T2).

$$TK_{lin} = \frac{(LF_{T_1} - LF_{T_2}) \cdot 100\%}{(T_1 - T_2) \cdot LF_{T_1}}$$

TK_{lin} is the value input at the menu
 LF_{T_1} conductivity at temperature T1
 LF_{T_2} conductivity at temperature T2

6.6 Design of the sensor GWO 5610

6.6.1 General

The oxygen sensor is an active sensor. It consists of a platinum cathode, a lead anode and potassium hydroxide (KOH) as an electrolyte. If oxygen is present, it is reduced on the platinum cathode and the sensor delivers a signal. If no oxygen is present, no signal is delivered. The anode is consumed by the oxygen measurement. The sensor ages. Furthermore, the sensor loses water through the permeable membrane, in particular, when it is stored in dry air. Therefore, it should be checked and maintained regularly and replaced as necessary.



The electrode contains potassium hydroxide. This causes burns. All contact with the skin, clothing and eyes should be avoided.

Nevertheless, should contact occur, take the following measures.

Eyes: Flush with flowing water for at least 15 minutes, seek medical attention!

Consult a doctor.

Always store oxygen sensor GWO 5610 wet!

- In a storage bottle filled with water or
- place in a container with water.



After prolonged storage before the measurement, clean the membrane with a soft paper towel of possible coverings (algae, bacteria, ...).

6.6.2 Design

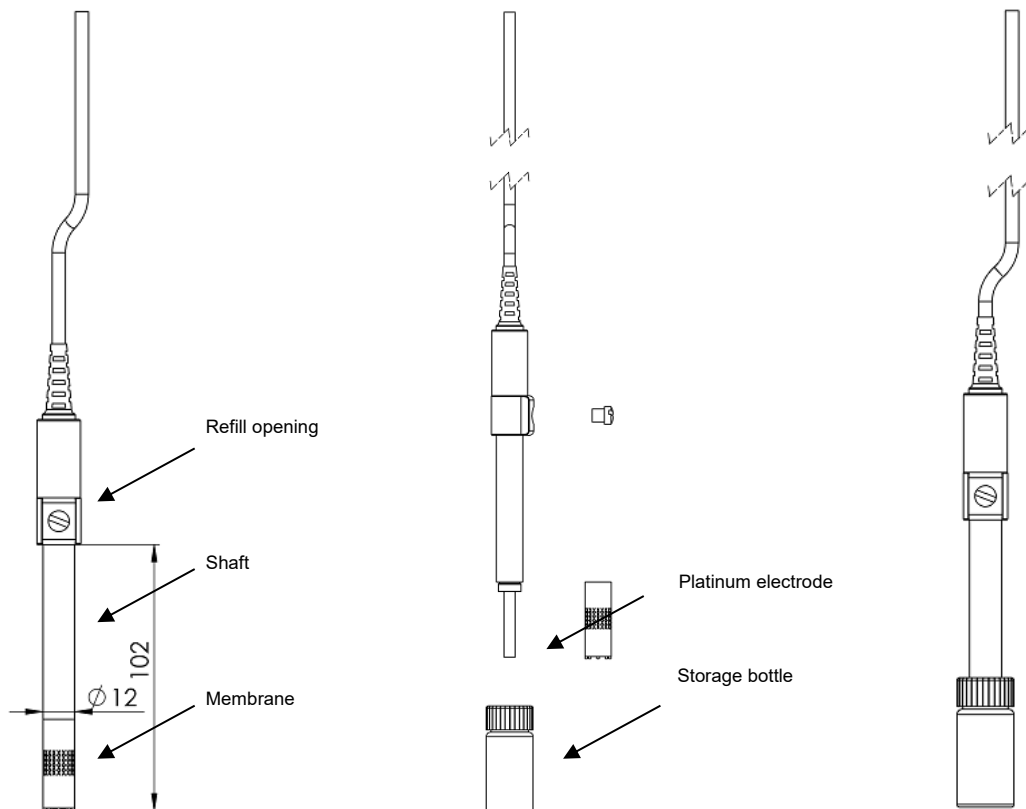

Platinum electrode

If oxygen is present, it is reduced on the platinum electrode and the sensor delivers a signal. Soiling on the platinum electrode or between the membrane and electrode can influence the measurement.

Storage bottle

The storage bottle is provided to keep the membrane moist. The service life of the sensor is extended as a result. Distilled or deionized water is in the storage bottle; do not add any other liquids!

Membrane head

The membrane head is covered with a thin plastic membrane. Faulty measurements will occur if the membrane is damaged or there are large air bubbles or even an air bubble ring on the membrane. This can also be the cause if a sensor can no longer be calibrated. The GWOK 02 membrane head is a spare part and can be re-ordered separately.

Refill opening

Electrolyte must be filled or added for the initial commissioning of a sensor which is delivered dry, when performing maintenance or after use at high temperatures.

6.6.3 Service life

The sensor signal deteriorates relatively quickly at the end of the service life of the sensors. The electrode evaluation in %, therefore, can only be used as a guide value. A value of 70% does not mean that exactly 70% of the service life is still available, rather that the electrode signal has 70% of a comparison signal.



The sensor evaluation is updated by the measuring device after a successfully performed calibration of the oxygen sensor.

The nominal service life can be reduced significantly due to use. Influential factors include:

- ▪ Storage / operating temperature
- ▪ Contamination of the measured water
- ▪ Mechanical stress of the sensor membrane
- ▪ Storage in dry air
- ▪ Continuous use in elevated carbon dioxide concentrations

6.6.4 Operating position

The oxygen sensor should be arranged vertically upwards with the connecting cable. A slight angle of inclination does not impair the measurement.

6.6.5 Measurement accuracy

The measurement accuracy can be impaired by:

- An inadequate flow below the necessary value of approx. 30cm/sec.
- The water temperature and sensor temperature must be the same. The most accurate measurements are provided when the measuring temperature is calibrated.

6.6.6 Visible residues inside the membrane cap

As a reaction product, lead oxides (brown or red, from reaction with oxygen) and lead carbonate (white, from reaction with carbon dioxide) are created during operation on the lead anode. These substances can collect on the membrane, but they do not usually affect the measurement function. Most of these substances can be removed during the maintenance of the sensor.

Prior to screwing on the membrane cap, they should be removed as far as possible in order to prevent particles from being trapped between the membrane and the platinum cup. A rapid or excessive formation of lead carbonate after commissioning is an indication of air in the sensor. This is usually due to incomplete filling or a leak due to improper fitting of the cap / fill screw or membrane leak.

6.7 Commissioning / filling of the sensor GWO 5610

The electrode contains potassium hydroxide. This causes burns. All contact with the skin, clothing and eyes should be avoided. Nevertheless, should contact occur, take the following measures.



- a) Eyes: Flush with flowing water for at least 15 minutes, seek medical attention!
- b) Skin: Wash with large amounts of water for several minutes!
- c) Clothing: Remove immediately!
- d) If swallowed: Drink large amounts of water, do not induce vomiting and seek medical attention!



Protective goggles must be worn for all of the following activities!



Protective gloves must be worn for all of the following activities!

The sensor is delivered dry. Therefore, the sensor is well-suited for storage. The sensor must be filled in good time before the measurement. A wait time of approx. 2 hours after filling should be planned in order to allow the sensor to stabilize.

6.8 Sensor GWO 5610 maintenance

After every calibration the sensor quality in % will be shown in the large digit display. When the quality is below 25 % the sensor should be maintained.

Attention! The electrolyte is corrosive.

To maintain electrode please proceed as follows:

1. Unscrew diaphragm head and wipe clean of electrolyte solution using a paper cloth. Do not touch electrolyte. If your skin had contact with electrolyte, immediately rinse thoroughly with clear water.
2. Clean silver cathode with sand paper (grain size 240). Do not polish silver cathode, surface should stay rough. Remove all dust.
3. Remove filling screw and top up lost electrolyte (e.g. using disposable syringe)
4. Put back and tighten filling screw.
5. Top up diaphragm head with electrolyte avoiding air bubbles and place on table (cover table with absorbent paper first).
6. Keep electrode in a vertical position and screw diaphragm head to the electrode from the bottom. Electrolyte will be forced out of the diaphragm head and spill over (put on disposable gloves or use paper towel to touch diaphragm head).
7. Wipe up excess electrolyte with paper cloth.
8. Check cathode for air bubbles.

If there are large air bubbles, remove diaphragm head again and repeat process as of point 5. If O-ring has been damaged, it has to be replaced.

When maintenance has been completed plug on protective flask. Re-connect electrode to measuring device and wait for at least 3 hours till electrode can be calibrated.

6.9 Basics about oxygen measuring

Please observe the following points when measuring dissolved oxygen:

- **For measuring remove the protective flask.**
- **Do not disconnect electrode from device.**

If electrode has been disconnected, wait 2..3 hours till the final electrode signal has settled

before carrying out measurements or a calibration.

- **Electrode needs to be calibrated** (p.r.t. 'How to calibrate oxygen electrode')
- **The temperatures of the electrode and of the liquid to be measured have to be identical**

(if necessary, wait till temperatures match)

- **The Electrode has to be submerged at least 3 cm into the liquid to being measured**

- **The measured liquid has to stream along the electrode membrane with at least 30 cm/sec**

for measurements to be sufficiently accurate: either stir continuously or use agitator.

- The electrode measurement is sensitive against shocks!

By stirring of the electrode in the measured liquid be careful that the electrode does not hit the

container. A vibration of the electrode has a effect to the measured value.

- The **optimum operation position** is: with the sensor inlet pointing downwards

The instrument calculates the oxygen concentration [mg/l], the oxygen saturation [%] from the electrode signal and the temperature. According to DIN38408-C22 all measurements refer to steam saturated air.

6.10 Ambient pressure and measuring depth of the electrode

The pressure at the sensor membrane is important for:

- The calculation of the oxygen saturation (%sat).
At air water can get 100% saturation. Assumed that there are no oxygen consuming processes (biological degradation, chemical effects) and that there are no oxygen enriching processes (e.g. excessive ventilation or photosynthesis)
- The calculation of oxygen concentration (mg/l or ppm)
- The electrode evaluation at calibration

Therefore it is necessary to compensate the pressure influence via integrated sensor or, like practiced with more primitive instruments via tables and manual input of pressure or Elevation above sea level values.

6.11 Correction of salinity

The higher the salinity (salt content) the lower the solubility of oxygen in water, i.e. although the partial oxygen pressure is the same, the quantity of oxygen dissolved in water (mg/l) is lower. Therefore, determination of the oxygen concentration requires entering the salinity of the medium (p.r.t. 'Configuration'). The correction of salinity is based on media on a water basis, whose chemical content is similar to sea water. The corrections are based on the 'International Oceanographic Tables' (IOT).

7 Configuration







There are various configuration parameters available depending on the product version and configuration. They can differ depending on the product version and configuration.

In order to configure the product, you must first open the device settings menu. The menu is opened as shown in the illustration. Prerequisite, The product is switched on.

1. Press the menu key for 1 second, to open the device settings menu.
2. The device settings menu appears in the display. The first parameter is shown.
3. By briefly pressing the Up button and the Down button, you can scroll through the parameters. Select the parameter you would like to configure.
4. When you have selected the desired parameter, select them with the function button F2. You can change the parameter to the desired value.
5. With the function button F1 you leave the device settings menu. The main display is shown.

Representation:

Call up menu	Next parameter	Change parameter	Change value	Save changes
				
1 s				

7.1 Device menu

	<-- -->	<--	
time and date			
USB-mode	mass storage COM port		
logging time			
logging	not activated cyclic on keypress		
logging time			
location	list		20 location names with up to 21 ASCII characters
language	German English		
backlight	auto-off	inactive active	
	brightness		
alarm activity	off sound blink sound and blink		

pH channels	inactive		
	active		
O2/cond. channels	inactive		
	active		
temperature channels	inactive		Temperature measuring always executed, just as a display option.
	active		

7.1.1 Time and date

Here time and date can be set. The time is shown on the left in the upper status line. When the time blinks, the time is invalid.



Depending on the language different time-zones are used. In German MESZ/MEZ (automatic setting of daylight saving time) is used, in all other languages UTC is used.



All time bases in terminal or data logging files are in UTC to ensure trouble-free data exchange.

7.1.2 USB-mode

7.1.2.1 Mass storage

In USB mass storage the device can no longer access the internal memory. The logger can no longer be started. Accessing the internal mass storage can be done without driver installation. Logger data can be copied or deleted.

The logger data are stored into a CSV file.

The location depends on the starting time of the logger.

Example: Logger was started 31st December 2020 at 19:11. The CSV files are then located in the folder \DATA\20201231\1911\ .

Single shot logger data is always stored inside the \HISTORY\ directory.

Calibration data are stored like logger data, but inside the \CAL_DATA directory.

7.1.2.2 COM port

In this mode the computer can directly communicate with the device after driver (windows only) installation. (115200 8N1 \r\n as end marking)

The following commands are supported:

GetChannelMenu: #	menu output with all settings
GetLastValue: #	output of the last measured value
GetCalibrationReport: #	displays the last calibration values
GetDeviceInformation: 0	device and license information
AddLocationDescription: ##	changes the location description of location ##

is the channel number starting from 0.

Nr.	channel	Data name (Prefix)
0	oxygen	O2
1	pH	PH
2	conductivity	COND
3	temperature (pH)	T_PH
4	temperature (O2/LF)	T_COND
5	air pressure	PRES
6	device menu (value = battery capacity in %)	DEV

7.1.3 Alarm activity

The alarm activity means what action should be done when an alarm (of any channel) is active. The alarm activity will happen only when a channel's alarm condition is true, the channel is active and the alarm function is activated. The device will show 'A' in the status line, even if the alarm activity is off.

7.1.4 Logger

Three different functionalities can be set

- not activated
- cyclic
- on keypress

7.1.4.1 not activated

The logger is not active, USB settings and channel calibration can be used.

7.1.4.2 cyclic

When the logger started, each channel will be recorded. The logging interval is in seconds. On record start, a new folder will be created in the mass storage (e.g. the logger was started 31st December 2020 at 19:11, a folder \DATA\20201231\1911\ will be created). In this folder the channel settings (JSON file) and the measured values (CSV file) are stored.

When the logger is set to on, channel settings can no longer be changed or calibration can no longer be performed. The device can no longer be turned off by the on/off button, instead the device menu will be shown.

To start the logger in the normal display the F1-key will be entitled with "start".

When the logger is running, the F1-key will be entitled with "stop" and can be stopped by pressing the F1-key.

7.1.4.3 on keypress

With "on keypress" one measuring will be added to the files inside the HISTORY directory. A location is also stored to this dataset, this can be selected from a list. The location description can be set via COM port interface command (see above). The location description must only contain ASCII-letters and numbers, no special characters. Up to 22 letters can be used for the location description. The maximum length of the location list is 20 entries.

The description text can also be changed directly in mass storage device. The folder LOCATION contains 20 *.LOC files that can be changed with every text editor. After changing the device must be restarted to read in the files.

In display mode the F1-key will be entitled with "snapshot", on each keypress of the F1-key one dataset is stored. During the saving progress the F1-key will be entitled with "wait..."

7.1.5 pH channels and O2/cond. channels

When set to 'inactive' all depending channels are turned off.

All these channels will no longer be shown in the display.

In any logger recording an error message will be stored for inactive channels. Only one of these options can be set to 'inactive'.

Temperature channels

When set to 'inactive' all temperature channels in the table view are no longer visible. The measuring will still be active, also in the large view of pH and O₂/cond channels the temperature (reference temperature) will be kept showing.

7.2 pH channel menu

	<--	-->	<--
measurement	pH		
	voltage		
	Voltage (H)		
alarm	function	off	
		on	
	min.-limit		
	max.-limit		
temp. compensation	ATC	off	
		on	
	reference channel	banana sockets	
		O ₂ /cond. electrode	
pH electrode	buffer	GMH standard	
		DIN standard	
		no detection	
	calibration mode	standard	
		strict	
	fast		

7.2.1 Temperature compensation

7.2.1.1 ATC

The automatic temperature compensation (ATC) can be switched on or off.

When deactivated, the temperature has to be set manually.

When activated the temperature is measured from the reference channel.

7.2.2 Reference channel

Here the channel for the ATC can be selected.

7.2.2.1 banana sockets

Reference temperature measured from RTD on banana sockets.

With a pH electrode with internal RTD only socket T is connected (common GND with BNC connector).

With an external RTD probe both sockets are used (as it's an RTD sensor, T or GND have no polarity).

7.2.2.2 O₂/cond. electrode

Reference temperature measured from oxygen or conductivity electrode. Inside the electrode is an integrated RTD sensor. The electrode needs to be inside the same fluid as the pH electrode. According to the size of the oxygen or conductivity electrode, the integrated RTD sensor is very slow.

7.2.3 Buffer

The buffers are auto detected. When the buffer is not recognized (no PHL or DIN buffer, very bad electrode, extreme temperature or contaminated buffer solution) the device will ask for manual input of pH value and temperature.

On manual input and using of the listed standard buffers, please check the electrode quality after calibration. If in doubt prepare new buffer solutions and clean or replace the electrode. At extreme temperatures, try to bring them to room temperature (20..25 °C).

7.2.3.1 PHL standard

For calibration the standard buffers for the GMH handheld instruments are used. These are pH 4 (red), pH 7 (green) und pH 10 (blue).

7.2.3.2 DIN standard

For calibration DIN standard buffers are used.

pH 1,680

pH 3,557

pH 3,776

pH 4,001

pH 6,881

pH 7,429

pH 9,225

pH 10,062

7.2.3.3 No detection

Device will ask for manual buffer input after detecting a stable value within the valid temperature range.

7.2.4 Calibration mode

This setting has strong influence about the accuracy and duration of the calibration process.

7.2.4.1 standard

allowed deviance 0,075 mV between last 45 measurements

7.2.4.2 strict

allowed deviance 0,075 mV between 45 measurements and allowed deviance 0,01 mV between last 10 measurements

7.2.4.3 fast

allowed deviance 0,23 mV between last 10 measurements

7.3 Temperature channel menu

Independent available for both, temperature (O2/LF) and temperature (pH)

sensortype	NTC 10 k		NTC 10 k only available for O2/LF
	Pt1000		
unit	°C		
	°F		
	K		
alarm	function	off	
		on	
	min.-limit		
	max.-limit		

7.3.1 Sensortype

The channel temperature (O2/LF) will change the sensortype automatically when an electrode is changed.

Conductivity electrode (LF 425) sensortype: Pt1000

Oxygen electrode (GWO 5610) sensortype: NTC 10 k

When other electrodes are used, the setting has to be changed manually.

Pt1000 is normally the correct setting for temperature (pH) as it's standard electrode is the GE 125.

When using different electrodes, check the manual of the electrode for the correct setting.

7.4 Oxygen channel menu

measurement	O ₂ concentration	[mg/l]	
	O ₂ saturation	[%]	
	O ₂ partial pressure	[hPa]	
alarm	function	off	
		on	
	min.-limit		
	max.-limit		
salinity			
auto pressure comp.	off		
	on		
absolute pressure			

7.4.1 Salinity

Input of salinity. The oxygen value will be re-calculated on values not equal to 0.

7.4.2 Auto pressure comp.

Automatic pressure compensation or manual input.

7.4.3 Absolute pressure

Manual input of the air pressure.

7.5 Conductivity channel menu

measurement	conductivity		
	salinity		
alarm	function	off	
		on	
	min.-limit		
	max.-limit		
cell factor			
auto-range	off		
	on		
range			
temp compensation	off		
	NLF		
	linear		
lin. coefficient			
reference temperature	T=25 °C		
	T=20 °C		

7.5.1 Cell factor

Manual input of the cell factor. G 7500 sets with conductivity electrode are preconfigured with the electrode's cell factor.

7.5.2 Auto-range

Automatic range selection of the conductivity measurement is active.
auto-range: 0 µS/cm..500 mS/cm

7.5.3 Range

Manual range selection when auto-range is not active.

45..500 mS (range: 1)

5,0..50,0 mS (range: 2)

500..5 000 µS/cm (range: 3)

0,0..500,0 µS/cm (range: 4)

7.5.4 Linearization

Linearization of the measured value according to nIF or manual input.

7.5.5 Lin. coefficient

Manual linearization coefficient (only with linearization is linear input).

7.5.6 Reference temperature

Reference temperature of the measured conductivity.

8 Error codes (in dataset)

While logging data or querying values via interface, the error codes will not be shown as human readable text. This is because the relation between error and error message would get lost between different languages.

Error code	Text	Hint
0	OK	no error
10000000	measuring range overrun	check calibration and sensor
10000001	measuring range underrun	check calibration and sensor
10000010	calculation failed	check settings
10000011	system error	restart device*
10000012	battery empty	recharge device
10000013	no sensor	connect sensor
10000014	recording error	restart device*
10000015	EEPROM checksum wrong	restart device*
10000016	system restarted	device is restarting, wait shortly
10000017	data pointer error	restart device*
10000018	data invalid	restart device*
10000020	recording stopped	logger has been stopped
10000021	recording started	logger has been started
10000022	channel deactivated	channel is deactivated via device settings
10000023	temp. channel deactivated	check temperature compensation settings, activate O2/cond. channel
10000024	no temp. sensor	plug in temperature sensor check temperature compensation settings, activate O2/cond. channel
10000025	no data available	device has not measured anything
-23	sensor module not responding	restart device*
-10	not existing	restart device*
-255	unexpected error	restart device*
-100	calibration error	try to calibrate again
-75	not found	restart device*
-101	not calibrated	perform a calibration
-253	Value not stable	Ensure a stable environment
-251	Not in the temperature range	Check temperature

*Resend device for service, when the error does not disappear

9 Calibration

9.1 General information

Each channel that supports a calibration will show cal. Above the F1-key. The Calibration will only be available when the logger is set to “not active”. When you press the F1-key the calibration wizard will guide you through the calibration steps. Depending on the channel you will need to have buffer solutions prepared.

More point calibration can be done (if supported from the measuring channel) after the 1st calibration point is finished. You don't need to select how many points should be calibrated and you don't need to follow a predefined order of buffer values, you can just use them in random order.

9.2 pH calibration

Required Accessories:

Buffer solutions (e.g. the PHL buffer solutions with ph 4, ph 7 and ph 10)

deionized water for cleaning between changing buffer solutions

If necessary, liquid thermometers to determine the temperature of the buffer solutions (if no GE 125 or similar is used)

Start the calibration process, see above.

Follow the instructions of the device:

Clean the electrode and immerse it in the first buffer solution.

After the buffer solution has been determined, continue with the next buffer solution or complete the calibration.

A certain sequence of buffer solutions is not specified.

If no temperature reference is present, the temperature of the buffer solution must also be determined with another measuring instrument and entered.

The electrode evaluation after completion of the calibration process informs about the state of the electrode.

9.3 O₂ calibration

Required Accessories:

GCAL 3610 calibration vessel for oxygen sensor, alternatively use a moist cloth.

deionized water for cleaning the sensor.

Start the calibration process, see above.

Follow the instructions of the device:

Clean the sensor and plug it into GCAL 3610.

Alternatively, wrap the sensor loosely into a moist cloth.

The sensor evaluation after completion of the calibration process informs about the state of the sensor.

10 Calibration and adjustment service

The certificates are categorised as ISO calibration certificates and DAkkS calibration certificates. The purpose of the calibration is to verify the precision of the measuring device by comparing it with a traceable reference.



The ISO standard 9001 is applied for the calibration certificates. These certificates are an affordable alternative to the DAkkS calibration certificates and provide information of the traceable reference, a list of individual values and documentation.



The DAkkS calibration is based on DIN EN ISO/17025, the accreditation basis recognised worldwide. These certificates offer high-quality calibration and consistently high quality. DAkkS calibration certificates can only be issued by accredited calibration laboratories which have demonstrated their expertise in accordance with DIN EN ISO/IEC 17025. The ISO calibration includes any necessary adjustment with the purpose of minimising a deviation of the measuring device.

DAkkS calibration certificates are accompanied with a list of individual measurements before and after the adjustment, documentation and, if applicable, graphic representation, calculation of the expanded measuring uncertainty and traceability to the national standard.



The product is delivered with a test report. This confirms that the measuring device has been adjusted and tested.



Only the manufacturer can check the basic settings and make corrections if necessary.

11 Replacing rechargeable batteries



Using damaged or unsuitable batteries can generate heat, which can cause the batteries to crack and possibly explode!



If the batteries have different charge levels, leaks and thus damage to the product can occur.

- Use new, high-quality batteries!
- Do not use different types of batteries!
- Remove depleted batteries and dispose of them at a suitable collection point!



Unnecessary screwing places the water-tightness of the product, among other things, at risk and should be avoided.



Read the following handling instructions before replacing batteries and follow them step by step. If disregarded, the product could be damaged or the protection from moisture could be diminished.

Required tools: 1x Phillips screwdriver PH 1

- Remove device from silicone cover.
- Unscrew 3 screws on the device bottom. Carefully open the top cover and fold to the right (see picture). The cover is attached to the PCB by a flexprint connector. When ripping out the flexprint connector from the socket, the keypad will no longer work and the device needs to be sent in for repairing.
- Carefully change the 3 rechargeable Ni-MH batteries (type AAA). Take care of the polarity that is printed inside the holder. The batteries have to slip in without any force.
- Check the sealing in top cover must be clean and without any damage.
- Attach top cover and hand-tight the screws. When tightened to strong or to weak the sealing can be affected.
- Insert device into silicone cover.

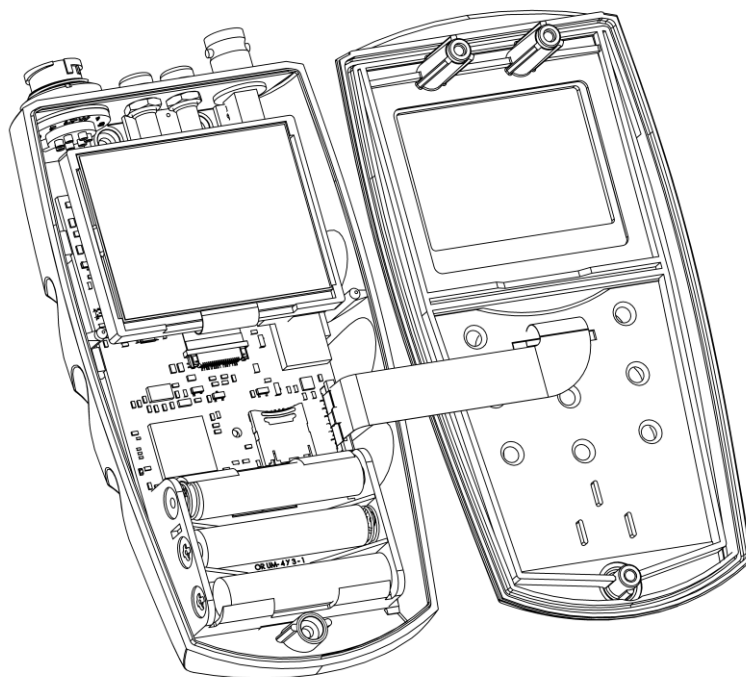

12 Reshipment and disposal

12.1 Reshipment



All devices returned to the manufacturer have to be free of any residual of measuring media and other hazardous substances.

Measuring residuals at housing or sensor may be a risk for persons or environment



Use an adequate transport package for reshipment, especially for fully functional devices. Please make sure that the device is protected in the package by enough packing materials.

Add the completed reshipment form of the GHM website

<https://www.ghm-group.de/infothek/#downloadcategory--8>

12.2 Disposal



Dispose exhausted batteries at destined gathering places. The device must not be disposed in the unsorted municipal waste! Send the device directly to us (sufficiently stamped), considering the above if it should be disposed. We will dispose the device appropriate and environmentally sound.

Private user can return the device at the municipal collection points for small electrical appliances.

13 Specification

13.1 Measurements and Accuracy

pH	
suggested probe	GE 125 (waterproof with Pt 1000 temperature probe)
connector	BNC plug (waterproof), <i>max. permissible cable length < 3 m</i>
pH	-2,00..+16,00 pH (+-0,25 % FS)
ORP	-2 000..+2 000 mV (+-0,25 % FS)
ORP (hydrogen referenced)	-1 775..+2 148 mV (+-0,25 % FS) <i>(for electrodes with 3 mol/l KCL electrolyte 0..100 °C)</i>
temperature compensation	automatic or manual <i>(via banana connector or O2/conductivity probe)</i>
accuracy requirements	Ta, Tm = 25 °C
dissolved oxygen	
suggested probe	GWO 5610 (with NTC 10 k temperature probe)
connector	7-pol. LTW (waterproof), <i>max. permissible cable length < 30 m</i>
oxygen saturation	0,0..500,0 % sat (+-1,5 % FS)
oxygen concentration	0,0..50,0 mg/l (+-1,5 % FS)
oxygen partial pressure	0..1013 hPa (+-1,5 % FS)
temperature compensation	automatic: 0,0..+50,0 °C
salinity correction	off, 0..70 g/kg
accuracy requirements	Ta, Tm = 20 °C, 100 % sat. O2 direct flow > 20 cm/s
Conductivity	
suggested probe	LF 425 (with Pt 1000 temperature probe)
connector	7-pol. LTW (waterproof), <i>max. permissible cable length < 3 m</i>
conductivity	auto-range: 0 µS/cm..500 mS/cm (+-0,5 % FS) 45..500 mS (Range: 1) 5,0..50,0 mS (Range: 2) 500..5 000 µS/cm (Range: 3) 0,0..500,0 µS/cm (Range: 4)
salinity	0,0..70,0 g/kg (+-0,5 % FS)
temperature compensation	automatic: -5,0..+100,0 °C
reference temperature	20 °C, 25 °C
linearization	off, manual linear input or non linear function for natural water according to DIN EN27888 (ISO 7888)
accuracy requirements	Ta, Tm = 25 °C
temperature (banana plug)	
sensor type	Pt 1000
Measuring range	Pt 1000: -10,0..+ 150,0 °C (+-0,25 % FS)

14 Terms of license

14.1 FreeRTOS

FreeRTOS Kernel

Copyright (C) 2018 Amazon.com, Inc. or its affiliates. All Rights Reserved.

Permission is hereby granted, free of charge, to any person obtaining a copy of this software and associated documentation files (the "Software"), to deal in the Software without restriction, including without limitation the rights to use, copy, modify, merge, publish, distribute, sublicense, and/or sell copies of the Software, and to permit persons to whom the Software is furnished to do so, subject to the following conditions:

The above copyright notice and this permission notice shall be included in all copies or substantial portions of the Software.

THE SOFTWARE IS PROVIDED "AS IS", WITHOUT WARRANTY OF ANY KIND, EXPRESS OR IMPLIED, INCLUDING BUT NOT LIMITED TO THE WARRANTIES OF MERCHANTABILITY, FITNESS FOR A PARTICULAR PURPOSE AND NONINFRINGEMENT. IN NO EVENT SHALL THE AUTHORS OR COPYRIGHT HOLDERS BE LIABLE FOR ANY CLAIM, DAMAGES OR OTHER LIABILITY, WHETHER IN AN ACTION OF CONTRACT, TORT OR OTHERWISE, ARISING FROM, OUT OF OR IN CONNECTION WITH THE SOFTWARE OR THE USE OR OTHER DEALINGS IN THE SOFTWARE.

<http://www.FreeRTOS.org>

<http://aws.amazon.com/freertos>

14.2 FatFS

FatFs - Generic FAT Filesystem Module Rx.xx

Copyright (C) 20xx, ChaN, all right reserved.

FatFs module is an open source software. Redistribution and use of FatFs in source and binary forms, with or without modification, are permitted provided that the following condition is met:

1. Redistributions of source code must retain the above copyright notice, this condition and the following disclaimer.

This software is provided by the copyright holder and contributors "AS IS" and any warranties related to this software are DISCLAIMED.

The copyright owner or contributors be NOT LIABLE for any damages caused by use of this software.