

## Flow Transmitter / Switch FLEX-HR2VE



- Optimised for use with oil
- Analog output and switching output
- Designed for industrial use
- Small, compact construction
- Simple installation
- Simple to use
- Cable outlet infinitely rotatable

### Characteristics

Mechanical flow switch, for fluid media, with spring-supported piston and magnetic triggering of Hall sensors. Robust construction in brass or stainless steel.

The FLEX transducer on the sensor has an analog output (4..20 mA or 0..10 V) and one switching output, which can be configured as a limit switch for monitoring minimal or maximal, or as a frequency output or a pulse output.

The switching output is designed as a push-pull driver, and can therefore be used both as a PNP or an NPN output. The state of the switching output is signaled with a yellow LED in the switching outlet; the LED has all-round visibility.

The sensor is configured in the factory, or alternatively this can be done with the aid of the optionally available ECI-1 device configurator (USB interface for PC). A selectable parameter can be modified on the device, with the aid of the magnet clip provided. In this case, the present measured value is saved as the parameter value. Examples of these parameters are the switching value or the metering range end value.

The stainless steel electronics housing is rotatable, so it is possible to orient the cable outlet after installation.

### Technical data

<b>Sensor</b>	analog Hall sensor	
<b>Nominal width</b>	DN 32 / 40 / 50	
<b>Process connection</b>	female thread G 1 <sup>1</sup> / <sub>4</sub> ..G 2 (further process connections available on request)	
<b>Metering range</b>	10..160 l/min	for details see table "Ranges"
<b>Pressure loss</b>	~ 4..7 bar at Q <sub>max</sub>	
<b>Q<sub>max</sub></b>	up to 160 l/min	
<b>Measurement accuracy</b>	±5 % of full scale value at constant viscosity	
<b>Viscosity-stability</b>	±10 % of full scale value (20-330 mm <sup>2</sup> /s)	
<b>Pressure resistance</b>	PS 200 bar	
<b>Medium temperature</b>	-20..+85 °C, optionally -20..+120 °C	
<b>Ambient temperature</b>	-20..+70 °C	
<b>Media</b>	oil	
<b>Wiring</b>	see section "Wiring"	
<b>Materials medium-contact</b>	<i>Brass construction:</i> CW614N nickelled, CW614N, 1.4305, 1.4310, hard ferrite,	<i>Stainless steel construction:</i> 1.4571, 1.4310, hard ferrite
<b>Materials, non-medium-contact</b>	electronic adapter electronics housing	CW614N nickelled Stainless steel 1.4305
<b>Supply voltage</b>	18..30 V DC	
<b>Power consumption</b>	< 1 W	
<b>Analog output</b>	4..20 mA / max. load 500 Ω or 0..10 V / min. load 1 kΩ	
<b>Switching output</b>	transistor output "Push-Pull" (resistant to short circuits and polarity reversal) I <sub>out</sub> = 100 mA max.	
<b>Hysteresis</b>	adjustable, position of the hysteresis depends on minimum or maximum	
<b>Pulse output</b>	pulse width 50 ms → max. output frequency < 20 Hz	
<b>Display (only with switching output)</b>	yellow LED (On = OK / Off = Alarm)	
<b>Electrical connection</b>	for round plug connector M12x1, 5-pole	
<b>Ingress protection</b>	IP 67	
<b>Weight</b>	see table "Dimensions and weights"	
<b>Conformity</b>	CE	
<b>Installation location</b>	Standard: horizontal inwards flow; other installation positions are possible; the installation position affects the display, metering and switching range.	

### Signal output curves

Value x = begin of the specified range  
 = not specified range

Current output

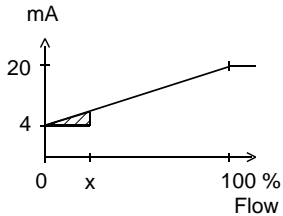

Voltage output

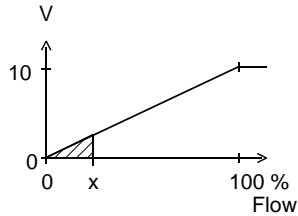

Frequency output

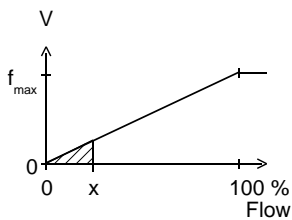

$f_{max}$  selectable in the range of up to 2000 Hz

Other characteristics on request.

### Ranges

Details in the table correspond to metering ranges with horizontal inwards flow and increasing flow rate.

#### Standard type FLEX-HRV2E

Metering range l/min oil 20-330 mm <sup>2</sup> /s	Q <sub>max.</sub> Recommended l/min	Pressure loss bar at Q <sub>max.</sub> oil
10 - 80	100	4
20 - 120	120	5
30 - 140	140	5
50 - 160	160	7

Special ranges are available.

#### Reference Data:

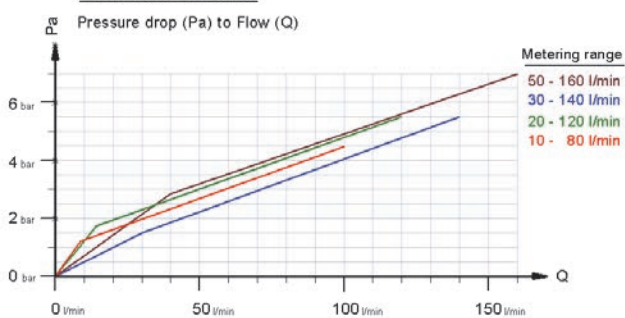

Metering spaces of the flow switch HR2VK1

### Wiring

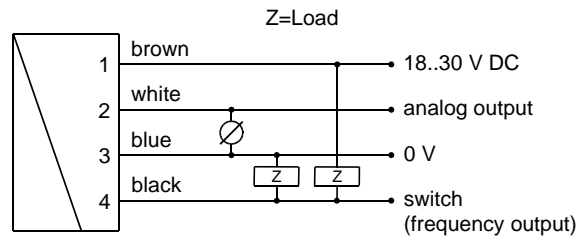

Connection example: PNP NPN

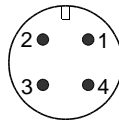

Before the electrical installation, it must be ensured that the supply voltage corresponds to the data sheet.

It is recommended to use shielded wiring.

The Push-Pull output can as desired be switched as a PNP or an NPN output.

### Dimensions and weights

..including FLEX-electronics

DN	G	Types	L	ØD	SW	Ød	X	Weight Kg
32	G 1 <sup>1</sup> / <sub>4</sub>	HR2VE-032GM	130	65	60	51	23	2.7
40	G 1 <sup>1</sup> / <sub>2</sub>	HR2VE-040GM	170	65	60	56	24	3.2
50	G 2	HR2VE-050GM	185	80	75	70	26	5.4

High temperature

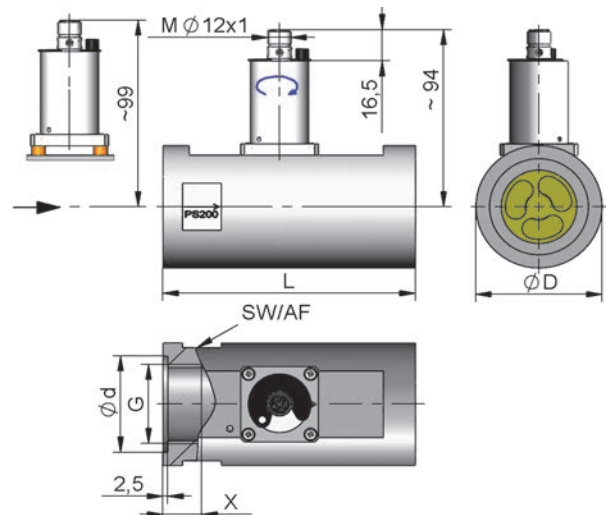

### Handling and operation

#### Note

- Include straight calming section of 5 x DN in inlet and outlet
- If the media are dirty, install a filter (use magnetic filter for ferritic components)
- Under unfavorable pressure conditions, e.g. with a free outlet, there is a risk of cavitation.

The electronics housing is permanently connected to the primary sensor. There is no electrical connection between the electronics and the piston device. After installation, the electronic head can be turned to align the cable outlet.

It should be ensured that the piston device and the FLEX electronics are appropriately matched to each other.

#### Programming

The FLEX electronics contain a magnetic contact, with the aid of which different parameters can be programmed. Programming takes place when a magnet clip is applied for a period between 0.5 and 2 seconds to the marking located on the label. If the contact time is longer or shorter than this, no programming takes place (protection against external magnetic fields).



After the programming ("teaching"), the clip can either be left on the device, or removed to protect data.

The device has a yellow LED which flashes during the programming pulse. During operation, the LED serves as a status display for the switching output.

In order to avoid the need to transit to an undesired operating status during "teaching", the device can be provided ex-works with a "teach-offset". The "teach-offset" value is added to the currently measured value before saving (or is subtracted if a negative value is entered).

*Example: The switching value is to be set to 70 % of the metering range, because at this flow rate a critical process status is to be notified. However, only 50 % can be achieved without danger. In this case, the device would be ordered with a "teach-offset" of +20 %. At 50 % in the process, a switching value of 70 % would then be stored during "teaching".*

Normally, programming is used to set the limit switch. However, if desired, other parameters such as the end value of the analog or frequency output may also be set.

The limit switch can be used to monitor minimal or maximal.

With a minimum switch, falling below the limit value causes a switchover to the alarm state. Return to the normal state occurs when the limit value plus the set hysteresis is once more exceeded.

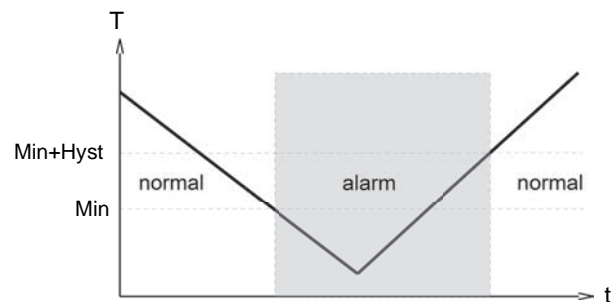

With a maximum-switch, exceeding the limit value causes a switchover to the alarm state. Return to the normal state occurs when the measured value once more falls below the limit value minus the set hysteresis.

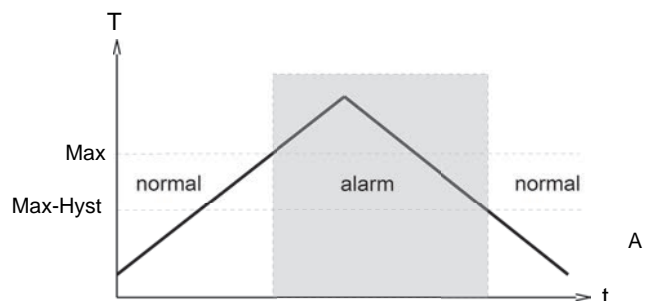

switchover delay time ( $t_{DS}$ ) can be applied to the switchover to the alarm state. Equally, one switch-back delay time ( $t_{DR}$ ) of several can be applied to switching back to the normal state.

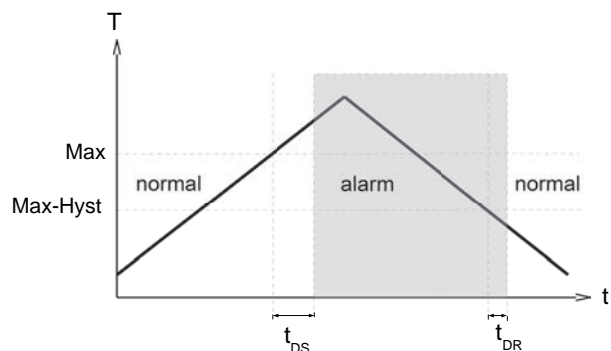

In the normal state the integrated LED is on, in the alarm state it is off, and this corresponds to its status when there is no supply voltage.

In the non-inverted (standard) model, while in the normal state the switching output is at the level of the supply voltage; in the alarm state it is at 0 V, so that a wire break would also display as an alarm state at the signal receiver. Optionally, an inverted switching output can also be provided, i.e. in the normal state the output is at 0 V, and in the alarm state it is at the level of the supply voltage.

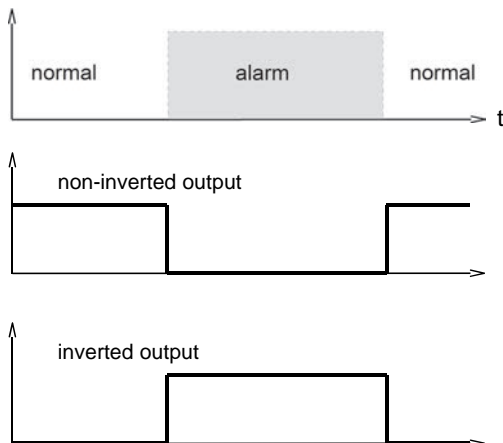

A Power-On delay function (ordered as a separate option) makes it possible to maintain the switching output in the normal state for a defined period after application of the supply voltage.

### Combinations with FLEX

FLEX-evaluation electronics can be combined with very different types of pickup systems for flow rate, level, temperature, and pressure. This has created a family of sensors with which different types of applications can be supported.

### Ordering code

The base device, e.g. HR2VE-032GM100 is ordered with electronics e.g. FLEX-HR2VE-ITLO

HR2VE -  1.  2. **G**  3.  4.

FLEX - HR2VE -  5.  6.  7.  8.

○=Option

<b>1. Nominal width</b>	
032	DN 32 - G 1 <sup>1</sup> / <sub>4</sub>
040	DN 40 - G 1 <sup>1</sup> / <sub>2</sub>
050	DN 50 - G 2
<b>2. Process connection</b>	
G	female thread
<b>3. Connection material</b>	
M	brass
K	stainless steel
<b>4. HR2VE - Metering range oil for horizontal inwards flow</b>	
080	10.. 80 l/min
120	20..120 l/min
140	30..140 l/min
160	50..160 l/min
<b>5. Analog output</b>	
I	current output 4..20 mA
U	voltage output 0..10 V
K	no analog output
<b>6. Switching output</b>	
T	Push-Pull
M	<input type="radio"/> NPN (open collector)

	K	no switching output
<b>7. Function set to switching output</b>		
	L	minimum-switch
	H	maximum-switch
	R	frequency output
	C	Pulse output
	K	no switching output
<b>8. Switching output level</b>		
	O	standard
	M	<input type="radio"/> inverted

### Required ordering information

#### For FLEX-HR2VE-C:

For the pulse output version, the volume (with numerical value and unit) which will correspond to one pulse must be stated.

Volume per pulse (numerical value)

Volume per pulse (unit)

### Options FLEX

Special range for analog output:  l/min

<= Metering range  
(Standard=Metering range)

Special range for frequency output:  l/min

<= Metering range (Standard=Metering range)

End frequency (max. 2000 Hz)  Hz

Switching delay period (0.0..99.9 s)  
(from Normal to Alarm)  s

Switch-back delay period (0.0..99.9 s)  
(from Alarm to Normal)  s

Power-On delay (0..99 s)  s

(After connecting the supply, time during which the switching output is not activated)

Switching output fixed  l/min

If the field is not completed, the standard setting is selected automatically.

### Options HR2VE

- Special quantities

### Ordering information

- Specify direction of flow, medium, and metering range.

### Accessoires

- Cable/round plug connector (KB...) see additional information "Accessories"
- Device configurator ECI-1