

# Pressure-Converter UNICON®-P

**Differential pressure - diminished pressure - overpressure -  
barometric pressure - flow rate**

## Features

- Measuring range programmable  
von -0.300 ... 0.300 mbar bzw. 0 ... 0.300 mbar  
bis -1000 ... 1000 mbar bzw. 0 ... 1000 mbar  
or 0 ... 2000mbar barometrical pressure
- Measuring function programmable  
linear or root extracting
- Measuring unit programmable  
e.g. mbar, Pa, hPa, psi, mmWVs  
optionally e.g. l/h, m<sup>3</sup>/h ....
- Output 4 ... 20mA, 2-wire loop powered  
0 ... 10V, 3-wire connection
- LCD-dot matrix display
- 2 electronic alarm outputs (opto coupler)
- Pressure simulation mode
- Protection IP65



Fieldcase  
100x100x60 mm (WxHxD)

## General

Pressure converters UNICON-P can be used for measuring low pressure, differential pressure in filter- and clean room technologie In connection with orifice plates, impact (dynamic) pressure, venturi nozzle it is suitable for measurement of flow rates of dry and non aggressive gases. Within the device dependent full scale range, output and display may be adjusted. The device offers' additional features like a unidirectional (e.g. 0 ... 1 mbar) or bidirectional (e.g. -1 ... 1 mbar) pressure range. The analog output depends to the programmed analog output.

## Short information

Programming	Parameters are programmed via a front side membrane keypad.
Display	The actual pressure/differential pressure will be displayed in the programmed measuring unit
Option 06 (display conversion)	With option 06, the flow rate can be displayed in a programmable unit as well. Further on the initial part of the transfer characteristic can be linearize or set to "0", to eliminate unstable measurement in this part.
Analog output	Proportional to the pressure (linear) or flow rate (root extracting) an analog output signal 4 ... 20mA or 0 ... 10V DC can be generated.
Zero point correction	Reset to zero via front side keypad possible.
Alarm output	Switching performance of the alarm outputs is programmable as minimum or maximum function. The state of the alarm outputs is shown in the LCD-Display.

## Content

Page

Pressure measuring ranges .....	2
Explanation of over-pressure .....	2
Technical Data .....	3
Connection diagram .....	4
Dimensions .....	4
Controls- und indicators .....	5
Instructions .....	5
Programming .....	6
Error Messages .....	11
Programming examples .....	11
Ordering code .....	12

## Programable pressure measuring ranges [mbar]

Device measuring range	1	2	3	4	5	6	9
unidirectional min. max.	0 - 0.300 0 - 3.000	0 - 1.00 0 - 10.00	0 - 3.00 0 - 30.00	0 - 10.0 0 - 100.0	0 - 30.0 0 - 300.0	0 - 100 0 - 1000	0 - 200 abs. 0 - 2000 abs.
bidirectional min. max.	± 0.150 ± 3.000	± 0.50 ± 10.00	± 1.50 ± 30.00	± 5.0 ± 100.0	± 15.0 ± 300.0	± 50 ± 1000	-
max. stat. over-pressure	200	200	300	600	1000	3000	4000
Burst pressure between process connectors	400	400	600	900	1500	5000	-
Burst pressure against ambient	600 (3000)	600 (3000)	600 (3000)	900 (3000)	3000	5000	7000

*Values shown in brackets are optional. See order code page 12, point 4*

## Explanation of over pressure

The maximum static over pressure can be held for a longer time without damaging the device.  
 The burst-pressure indicates a limit value which will damages the device in any case, when exceeding.

Max. static over pressure is valid between both process connections and also against the ambient.  
 Burst-pressure against ambient means same pressure is applied to both process connections.

## Technical data

### Power supply

Supply voltage	: 7.5 ... 30 V DC, 2-wire loop powered 4 ... 20 mA 16 ... 30 V DC, 3-wire 0 ... 10 V
Operating temperature	: 0 ... 50 °C
Isolation	: between Analog output/Alarm output1/Alarm output2
Rated voltage	: 500 V DC, between Analog output/Alarm output1/Alarm output 2
CE - conformity	: EN50022, IEC61000-4-3/4

### Measuring input

Process connection	: 2 pressure tubes for 4 mm hose (standard), 4 and 6 mm Schott glands available
Measuring medium	: neutral and dry gases in range of 0...50 °C
Measuring principle	: piezoelectric
Rise time	: parameter input filter low=120 ms, med=1400 ms, high=4100ms

### Output pressure

Current output	: 4 ... 20 mA ext. burden RA [Ω] ≤ $\frac{\text{Supply voltage} - 7.5 \text{ V}}{0.02 \text{ A}}$
Voltage output	: 0 ... 10 V load < 3 mA, supply voltage >16 V load < 10 mA, supply voltage >20 V
Basic accuracy	: ± 0.25 % ± 1 Digit, depends on the device measuring range
Temperature coefficient	: < 0.01 %/°C linear and ratio
Zero drift	: < 0.02 %/°C linear or 0.04 %/°C ratio*)

### Alarm output

Transistor	: 7.5 ... 30 V DC, max. 60 mA, with short circuit protection
Voltage drop	: < 3 V (at max. load)

### Display

Format	: LCD-dot matrix, 3.8 mm high
True value	: 2 lines, 16 characters
	: Standard -9999 ... 9999 Digit
	: Display conversion -99999 ... 99999 digit (option 06)
Measuring ratio	: Parameter input filter low = 8/s; med and high= 2/s;

### Case

Material	: Field case
Dimensions	: case polyamide with fibre-glass PA6-GF/GK 15/15, front foil polyester,
Weight	: 100 x 100 x 60 mm (WxHxD)
Electrical connection	: max. 360 g
Protection	: Screw terminal with pressure plate, 2.5 mm <sup>2</sup> flexible, 4 mm <sup>2</sup> wire
	: IP65, terminals IP20 German BGV A3

\*) ratio : start of curve linear up to 20% of the measuring range

## Connection diagram

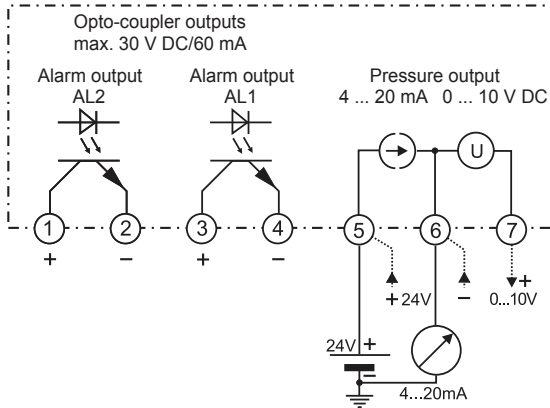

**Note:** For supplying the converter use terminals 5 and 6 as shown. If the converter is used for monitoring only, terminals 5 and 6 can be connected directly to supply voltage.

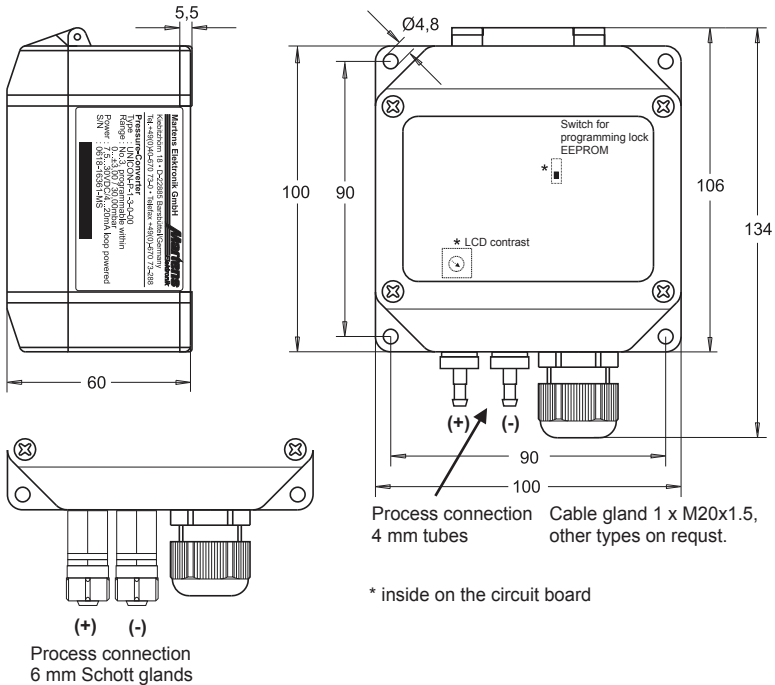

\* inside on the circuit board

## Controls and indicators

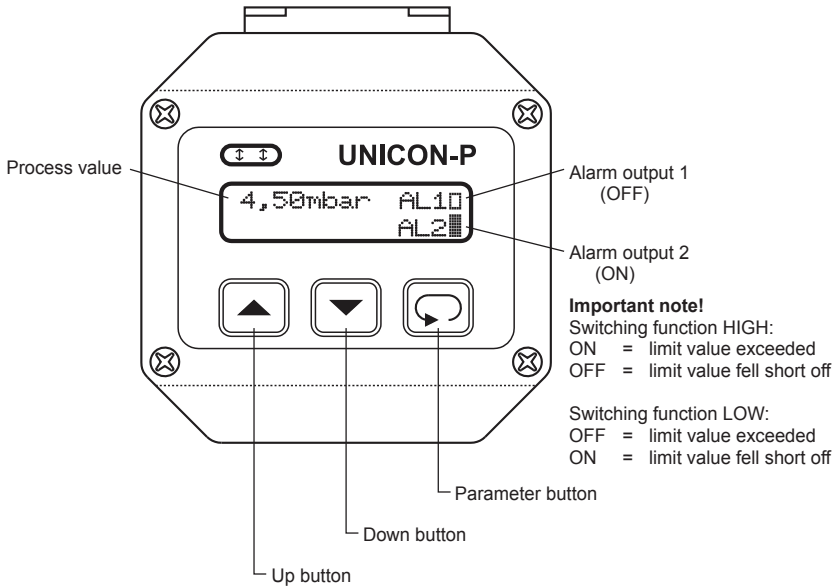

## Instructions

Programming of the device is arranged in the **configuration level**.

The desired parameter can be called by button . For selection within a parameter use buttons and .

Button combinations (press buttons at the same time):

- + 1 Parameter back
- + Parameter to "0" or minimum value

When the power supply is switched on, the UNICON initializes itself. The display shows the device type and software version. After initializing, the current measured values are displayed.

The **configuration level** is called-up by pressing the button . Now all the parameters defining the function of the UNICON can be programmed. After pressing the button again, the entered data will be stored.

When the configuration is finished, or when no button is pressed for more than 90 seconds, the program jumps back to the working level. Leaving the **configuration level** is possible at any time when pushing the button for 2 seconds.

### Installation note:

After installation, the device must be configured for the intended use. See page 6.

## Programming

Notes to representation



Parameter is only displayed if configured

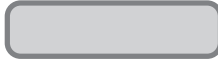

Parameter is only displayed if included (see order code)

### Note!

During the configuration only those parameters will be displayed, which are not excluded by other parameter settings. If parameter length exceeds 16 characters, the remainder is available by pushing buttons ▲ and ▼.

## Configuration level

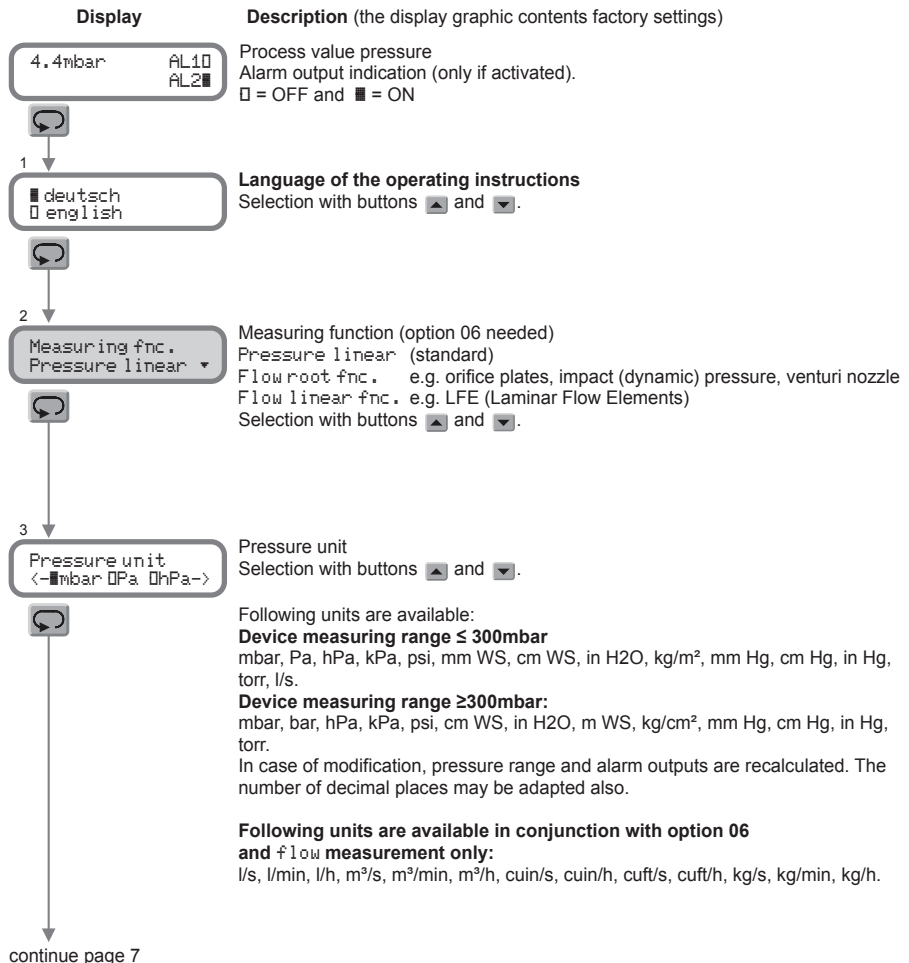

## Display

**Description** (the display graphic contents factory settings)

4  
Decimals  
n=?...? n=1

### Decimal point position

Selection with buttons and .

The possible number of decimal points is dependent of the selected pressure unit. If no decimal point is available, this parameter is not visible.



5  
Start of curve  
root function

*Needs option 06 and measuring function Flowroot fnc.*

### Start of curve

Selection with buttons and .

In its origin the root function has a great elevation, what can produce deflections in the display and output. To prevent this, the UNICON-P offers the possibility to transfer the curve at the beginning linearly or set to "0". On a programmed threshold point the root function is continued (see diagram).

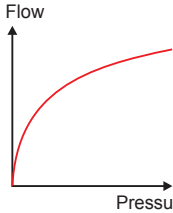

Start with root function

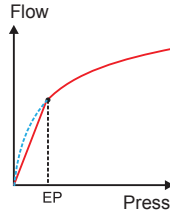

Start with linear

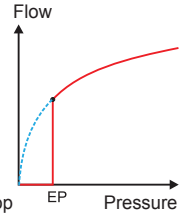

Start with set to zero

6  
Threshold point  
10.0%

*Needs option 06 and Start of curve linear or set to zero*

### Threshold point TP

Setting possible from 0.1 ... 20.0% of the device measuring range with buttons and .

Before this point an appropriate measuring error will be produced.



7  
Display conv.  
Factor: 1.000

*Needs option 06 and measuring function Pressure linear*

### Conversion factor for the display

Setting possible in range 0.001 ... 999.999 digit with buttons and .

**Note:** The following parameters depend on the converted device measuring range.



8  
Pressure drop  
1.0mbar

*Needs option 06 and measuring function Flow*

### Pressure drop (differential pressure) at the measuring device at a nominal flow (see parameter 9).

Setting possible in the (positive) device measuring range with buttons and .



## Display

## Description (the display graphic contents factory settings)

9  
 Nominal flow  
 100.0m<sup>3</sup>/h

*Needs option 06 and measuring function Flow*

### Nominal flow at a programmed pressure drop.

Setting possible with buttons ▲ and ▼.

**Note:** Following parameters depends on the converted device measuring range. Process value and parameters can be displayed and programmed in range of max. -99999 ... 99999 digit.

10  
 Input filter  
 LOW MED HIGH

### 3-step input filter

LOW	low filter effect	(fast response time)
MED	medium filter effect	(normal response time)
HIGH	high filter effect	(slow response time)

for smoothing display and output signal while pressure will wobble.

Selection with buttons ▲ and ▼.

11  
 Proc. value=0  
 by key ▲ : 0.0

### Zero correction

**(not displayed on devices with barometrical measuring range 9)**

Pressing the button ▼ will set the actual value to 0.

**Note!** Don't use this parameter with any process connection. On flow measuring with parameter Start of curve is set to zero a linear function is selected for the displayed value.

For lower pressure measuring range, selected with high resolution (e.g. measuring unit mbar with 2 decimals), the zero correction is only possible for input filter MED or HIGH.

12  
 Output  
 4-20mA 0-10V

### Output signal selection

4 ... 20mA or 0 ... 10V DC

Selection with button ▲ and ▼.

Device type UNICON-P-2-X-X-XX only

13  
 Start range (4mA)  
 0.0mbar

### Start value of measuring range (value for 4 mA or 0 V output)

Setting possible within device measuring range

with buttons ▲ and ▼.

14  
 End range (20mA)  
 10.0mbar











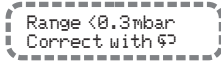

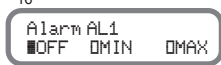

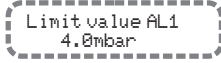

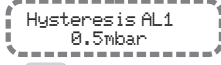

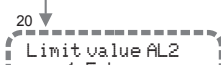

### End value of measuring range (value for 20 mA or 10V output)

Setting possible within device measuring range

with buttons ▲ and ▼.

**Note:** If Start range > End range the output works with decreasing characteristic.



Display	Description (the display graphic contents factory settings)
15 	<b>Correction of the pressure range</b> (only displayed if the programmed measuring span is too small) The minimum allowable span will be displayed. Please return to parameter Start range with button  and correct Start range or End range for minimum span.
16 	<b>Switching function AL1</b> Selection with button  and  .
17 	<b>Setpoint AL1</b> Setting possible in the device measuring range with buttons  and  .
18 	<b>Hysteresis AL1</b> Setting possible from 1 digit ... End range with button  and  .
19 	<b>Switching function AL2</b> Selection with button  and  .
20 	<b>Setpoint AL2</b> Setting possible in the device measuring range with buttons  and  .
21 	<b>Hysteresis AL2</b> Setting possible from 1 digit ... End range with button  and  .
22 	<b>Simulation of the pressure (manual operation)</b> The converter works in simulation mode. The output current changes within 4 ... 20 mA (or 0 ... 10 V) according to programmed pressure range. Setting possible with the buttons  and  .



**Please note:** This parameter will **not** be left automatically after 90 seconds.

**Display**

**Description** (the display graphic contents factory settings)

23  
 Corr. P-output  
 Initial: 4.00mA



**Correction of analog output initial value**

Setting possible from  $\approx 3.70 \dots 7.50\text{mA}$   
 with the buttons  and .  
 (Not available with output 0 ... 10 V DC)



24  
 Corr. P-output  
 End: 20.00mA



**Correction of analog output end value**

Setting possible from  $\approx 16.80 \dots 21.00\text{mA}$   
 with buttons  and .  
 (Not available with output 0...10 V DC)



25  
 Parameter lock  
 ■OFF 00N

**Parameter lock**

If activated only the setpoint of the alarm outputs AL1 and AL2 will be displayed (if enabled).  
 Selection by pressing button  or  longer then 2 sec.



26  
 Factory setting  
 Code=0

**Parameter for factory setting**



4.4mbar AL10  
 AL2■

**Return to the working level**

## Error codes

### Display

### Description and remedy

#### Display flashes

Overrange of the measuring range

Write protect!!

A changed parameter setting can not be stored, because the write protection is activated by internal slide switch at position "on". Set the switch at position "off" and modify settings again.

Parameter error  
->Please check

While examination of parameter memory XX, errors were detected. Quit display message with button  and check parameter settings. If the errors occurs again, a factory check is necessary.

Range <X  
Connect with \$P

The minimal range (X) according to the device measuring range fall below while configuration. Check and change measuring range (see parameter 15).

## Programming examples

No. Parameter : Parameter values

### Absolute pressure measuring

Device measuring range 2000 mbar/hPa abs.

800 ... 1200 hPa is corresponding with the output signal 4...20mA

```
3  Display unit      : hPa
10 Input filter     : MED
14 Start range (4mA) : 800
15 Endrange (20mA)  : 1200
```

### Flow rate measuring with Impact-pressure sensor (needs option 06)

Pressure drop 1.6 mbar at 200m<sup>3</sup>/h volume flow

Maximum flow 250m<sup>3</sup>/h is corresponding with the output signal.

Device measuring range 3mbar

```
2  Measuring func.   : Flow rate rad.
3  Display unit     : m3/h
4  Decimals        : 1
5  Start of curve   : linear
6  Threshold point  : 10.0%
8  Pressure drop    : 1.60mbar
9  Nominal flow     : 200.0m3/h
10 Input filter     : MED
11 Proc. value = 0  : Controlling is necessary at pressure-less system or open process inputs.
                    : If necessary set to "0.000".
14 Start range (4mA) : 0.0m3/h
15 Endrange (20mA)  : 250.0m
```

## Ordering code

UNICON-P -  1. -  2. -  3. -  4.

### 1. Type

- 1 Output 4...20 mA,  
2 electronic alarm outputs,  
supply voltage 7,5 ... 30 V DC, loop powered
- 2 same as 1, with additional output 0 ... 10V DC selectable,  
supply voltage 16 ... 30 V DC, 3-wire connection

### 2. Device measuring range [mbar]\*

- 1 3 rel.
- 2 10 rel.
- 3 30 rel.
- 4 100 rel.
- 5 300 rel.
- 6 1000 rel.
- 9 2000 abs. (barometrical pressure)

### 3. Process connection

- 0 4 mm tubes (standard)
- 2 4 mm Schott glands
- 3 6 mm Schott glands

### 4. Options

- 00 without option
- 06 Display conversion (e.g. flow rate)
- 11 Extended burst pressure (max. 3000 mbar) for measuring ranges 1 ... 4

\*The required pressure range is programmable down to 10 % of full scale within the selected device measuring range. Please consider that measuring error is increased with amplification.

Example:

Device measuring range 3	⇒ 30 mbar
programmed pressure range	⇒ 0 ... 10 mbar
Amplification [V]	⇒ 3x
Measuring error V x accuracy	⇒ = 3 x 0.25 % = 0.75 %

Variation of temperature while operating will produce additional temperature errors (see technical data).